

Luminaria para interior

Código: CL-50-50-COB-4K

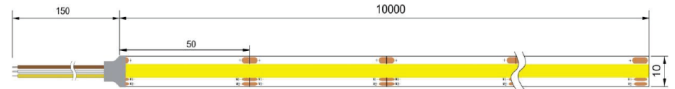
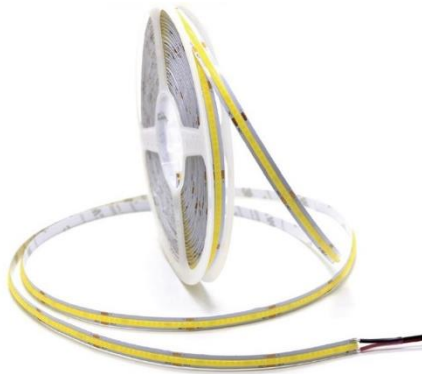

Dimensiones (mm)

Largo: Rollo 5000.
Ancho: 10.
Alto: 7.
Peso luminaria: 0,25 kg.

Dimensiones de empaque (mm)

Ancho: 20.
Largo: 240.
Alto: 220.
Unidad de empaque: 1 unidad por caja.

10W	2 AÑOS GARANTIA
325 Lm	IP20
143°	25.000

Descripción técnica

Cinta de LED flexible, con módulo continuo. Los tramos permitidos de corte son cada 50mm.

Tipo de montaje

Retirar el protector adhesivo ubicado en la parte posterior de la cinta LED y ubicarlo en la superficie deseada.

Materiales y acabado

Cobertura y cuerpo en silicona.

Colores disponibles



Transparente.

Para solicitar un color diferente contactarse con la empresa.

Nota: Debido a continua investigación, nos reservamos el derecho de cambiar especificaciones sin previa notificación.

Luminaria para interior

Código: CL-50-50-COB-4K

Características técnica

Fuente lumínica <i>Light technology</i>	LED
Grado de protección IP <i>IP rate</i>	20
Grado de protección IK <i>IK rate</i>	02
Ángulo de apertura <i>Beam angle</i>	143°
Temperatura de operación (°C) <i>Operation Temperature</i>	-5-50°C
Vida útil (Horas) <i>Life</i>	25,000
Voltaje de operación (V) <i>Voltage</i>	12V
Factor de potencia (PF) <i>Power Factor</i>	0.65
Tipo de control <i>Dimming Control</i>	<input type="checkbox"/> Fase <input checked="" type="checkbox"/> On / Off <input type="checkbox"/> 0-10V <input type="checkbox"/> DALI
Potencia (W) <i>Power</i>	10 W
Lúmenes de salida (Lm) <i>Luminaire Output</i>	325 Lm
Eficacia (Lm/W) <i>Luminaire Efficiency</i>	33 Lm/W
Color de temperatura (K) <i>Colour temperature</i>	4,000K
Índice de reproducción cromática (IRC) <i>Color Rendering Index (CRI)</i>	>90

Nota: Los lúmenes y la potencia tienen una tolerancia $\pm 10\%$.

Código: CL-50-50-COB-4K

Notas

- Precaución de corte:

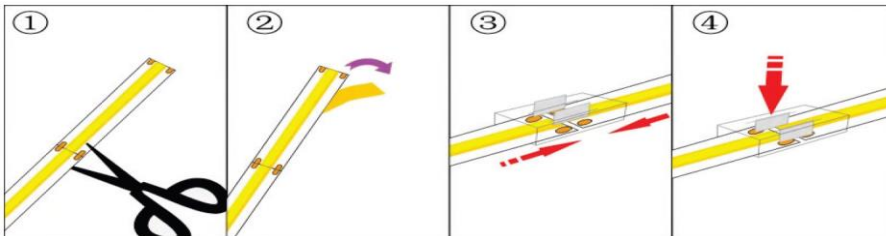

- Precaución de flexibilidad:

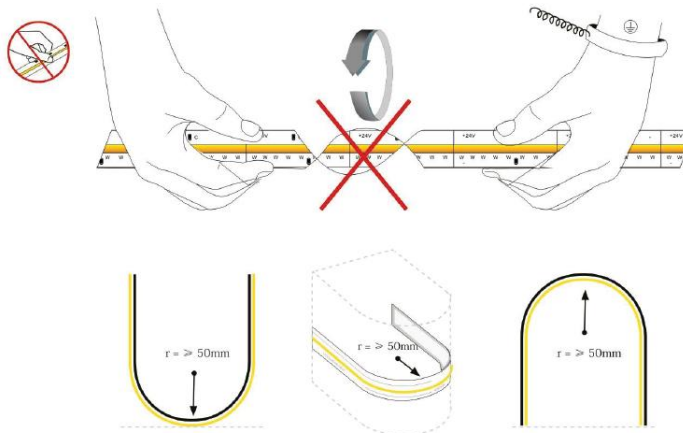

Manual de Instalación

Se debe tener en cuenta la alimentación de la luminaria, para ubicarla.

1. Medir el perfil o el espacio donde se ubicará la cinta. Tener en cuenta la modulación de corte para modular de manera correcta.
2. Cortar la cinta según las indicaciones.
3. Limpiar la superficie donde se va a ubicar, retirar el protector adhesivo ubicado en la parte posterior y sobreponerlo en la superficie deseada.
4. Conectar el final de la cinta al conector y este a la fuente de alimentación.
5. Verificar que la conexión.

Nota: Distecsa garantiza el buen y correcto funcionamiento del sistema eléctrico antes de ser instalado, algún retroceso o falla en el sistema corre por parte del personal de instalación.

Mantenimiento de luminaria

Es esencial llevar a cabo periódicamente inspecciones y mantenimiento a las luminarias instaladas, ya que estas reciben influencia de las condiciones de operación y del medio donde se ubican.

1. Mantenimiento correctivo

El mantenimiento correctivo de las luminarias consiste en localizar, reparar y adecuar las instalaciones para que funcionen el máximo número de horas posible, con el desempeño para el que fueron diseñadas.

Las actividades que componen el mantenimiento correctivo son:

- Localización y reparación de averías
- Adecuación de instalaciones

Para la ejecución del mantenimiento correctivo es importante tener en cuenta los siguientes aspectos:

- Si se genera algún inconveniente en la regleta LED por favor comunicarse con la empresa.
- Revisar el encendido, apagado y el correcto funcionamiento de la luminaria.
- Limpiar las regletas LED y el conjunto óptico de las luminarias con aire comprimido. Para manipular la luminaria se recomienda utilizar guantes quirúrgicos.

2. Mantenimiento preventivo

Dentro de las técnicas de diagnóstico se deben considerar las mediciones eléctricas en diferentes puntos de la red, así como la medición de parámetros eléctricos de operación de las luminarias y sus componentes.

3. Mantenimiento de las instalaciones eléctricas de las luminarias

La persona encargada de la operación y el mantenimiento de las instalaciones eléctricas de las luminarias será responsable de mantenerlas en condiciones seguras, por lo tanto deben garantizar que se cumplan las disposiciones del reglamento que establece los requisitos que deben cumplir los sistemas de alumbrado y verificar que estas conexiones no presenten ningún riesgo para la salud o la vida de las personas, animales o el medio ambiente.

Light efficiency:



Light quality:



Color temperature:



Output: 325 lm
Peak: 431 ccd
Power: 10 W
PF: 0,65

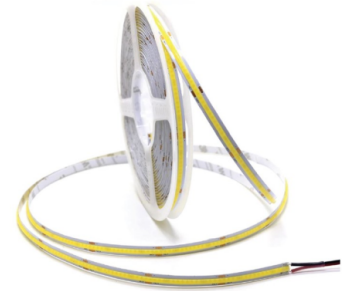

Product name:
E0927-CL-50-50-COB-4K 1M

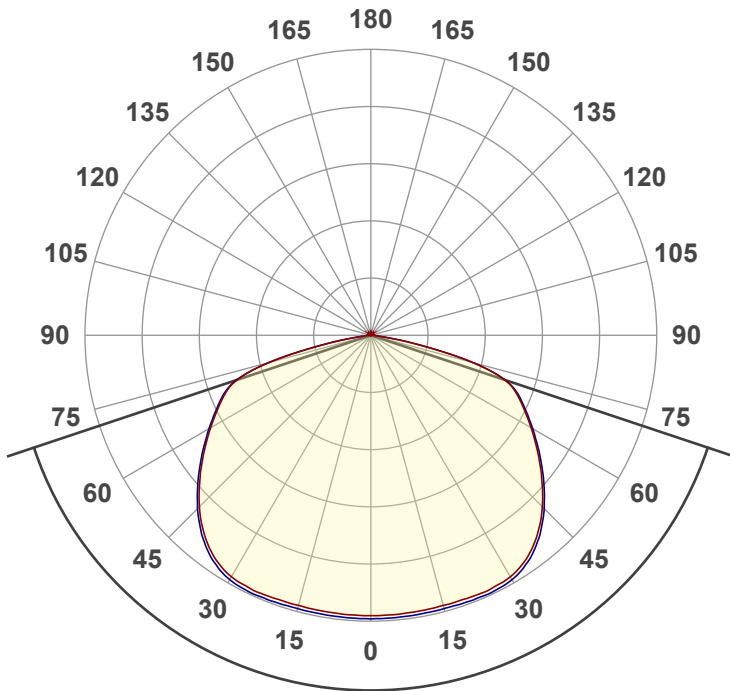

Beam angle **143,1°**



CIE 1931
x: 0,385
y: 0,380

THD Values:

Voltage: 4,51%
Current: 107,96%

Spectra

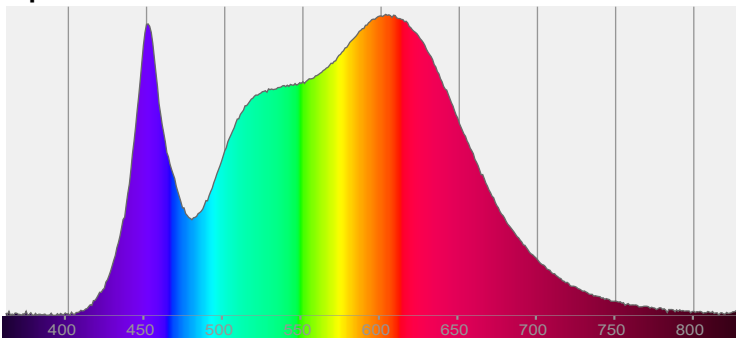

Power

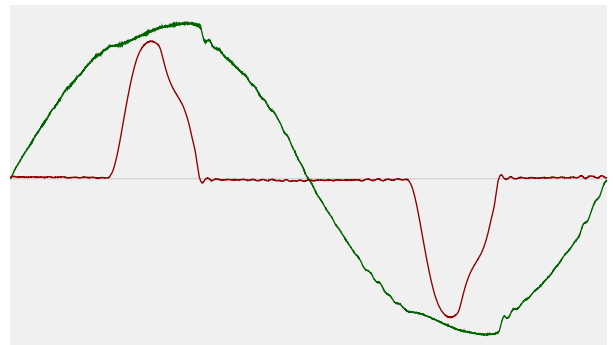

Voltage: 114 V
Current: 0,972 A
Frequency: 60,1 Hz

ISO Diagrams

ISO lux diagram

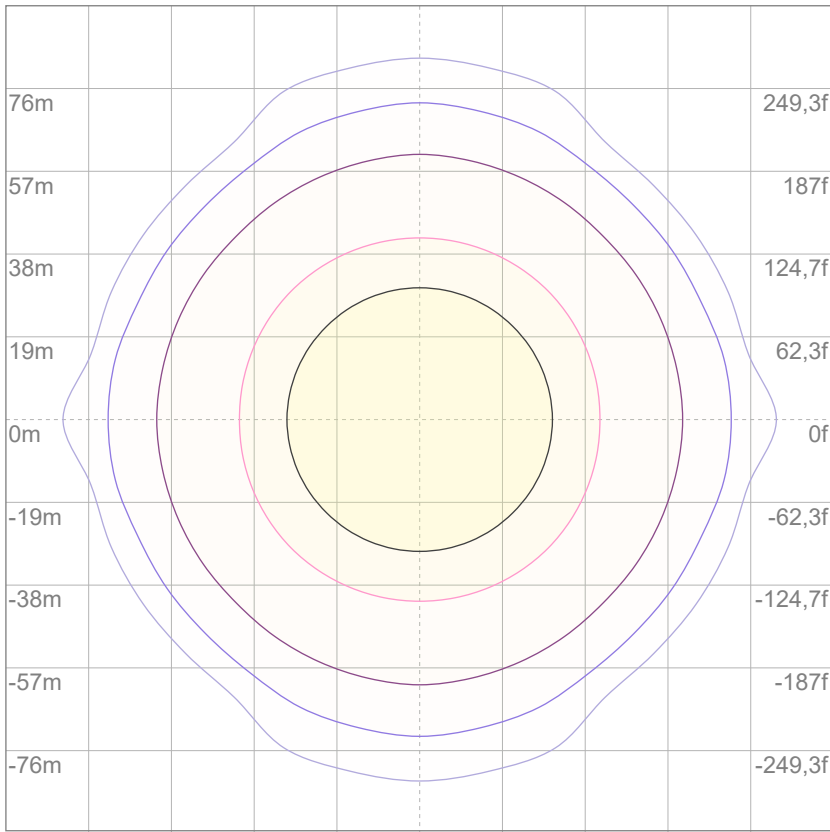

— 3%	0,128 lx
— 5%	0,213 lx
— 10%	0,427 lx
— 30%	1,28 lx
— 50%	2,13 lx

Conditions:
 Number of c-planes: 8
 Lux at center: 4,27 lx

Lux distribution on a surface when lamp is mounted at 10 meters from the surface.

Mounting height: 10 meters (33 f)

Color details

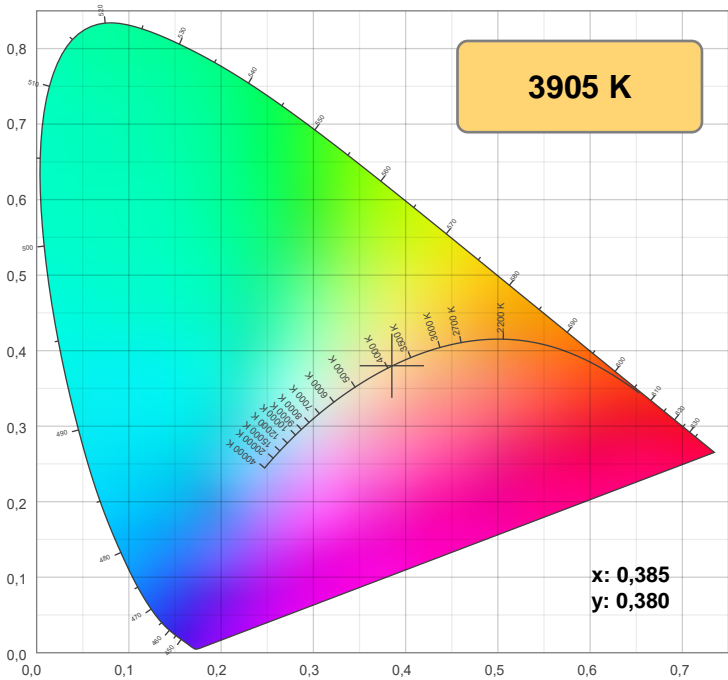

CIE 1931

CRI: 90,5 (R1-R8)

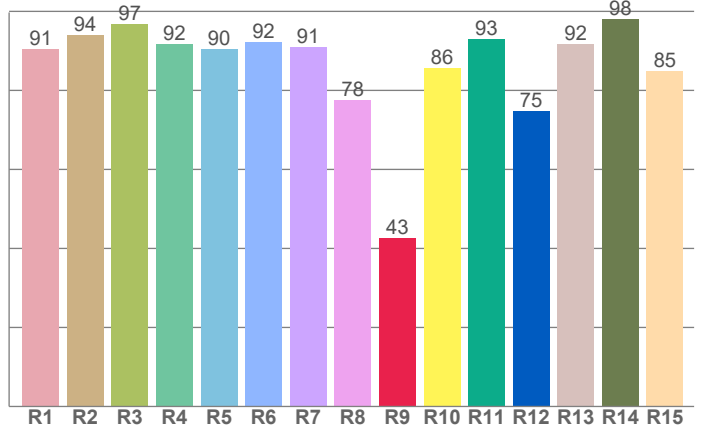

CRI R values, only R1-R8 are used to calculate final CRI value

R1	R2	R3	R4	R5	R6	R7	R8	R9	R10	R11	R12	R13	R14	R15
90,5	94,0	96,7	91,8	90,5	92,2	91,0	77,6	42,6	85,7	93,0	74,7	91,7	98,0	84,8

Color parameters

Color temperature	Color rendering index	Red component	Color fidelity	Color gamut	Color quality scale	Color coordinate cie 1931	Color coordinate cie 1931	Color coordinate	Color coordinate	Color deviation from black body
CCT	CRI	CRI R9	TM30 Rf	TM30 Rg	CQS	x	y	u	v	Δuv
3905 K	90,5	42,6	90,1	98,7	89,8	0,385	0,380	0,227	0,336	0,0002

TM-30 details

Rf 90,1
Fidelity index Rf

Rg 98,7
Gamut index Rg

Hue Bin	R _f	Shifts (%)	
		Chroma	Hue
1	88	-7%	-1%
2	91	-4%	3%
3	87	-2%	6%
4	93	0%	4%
5	93	0%	3%
6	96	2%	0%
7	96	-1%	-1%
8	95	-2%	0%
9	93	-3%	4%
10	87	-4%	7%
11	85	2%	10%
12	88	5%	3%
13	89	5%	-6%
14	92	6%	-5%
15	87	0%	-9%
16	85	-3%	-9%

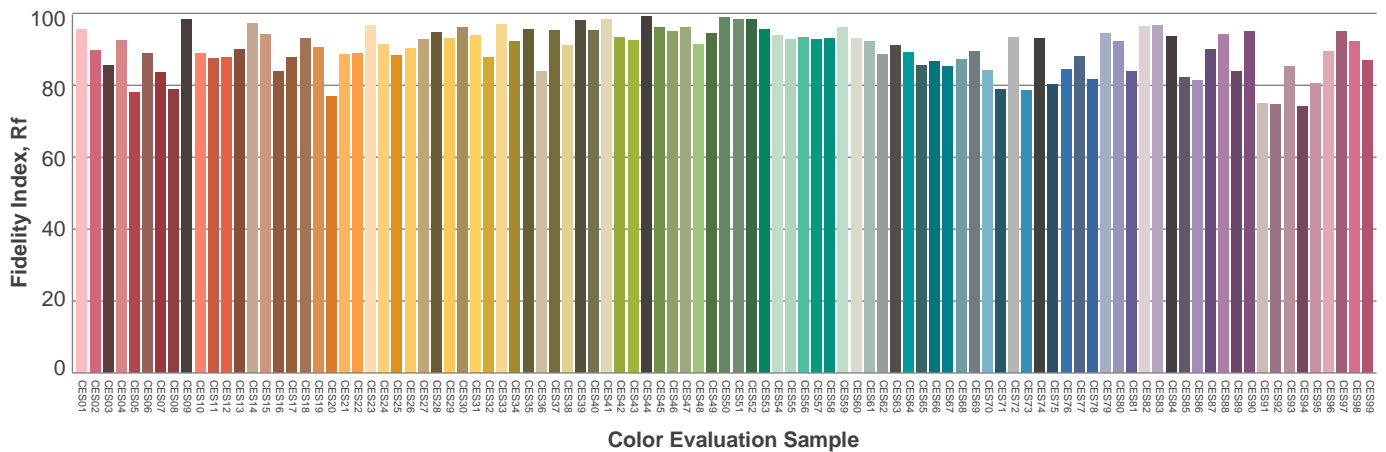
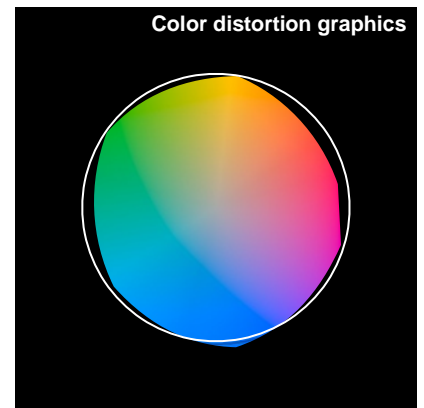
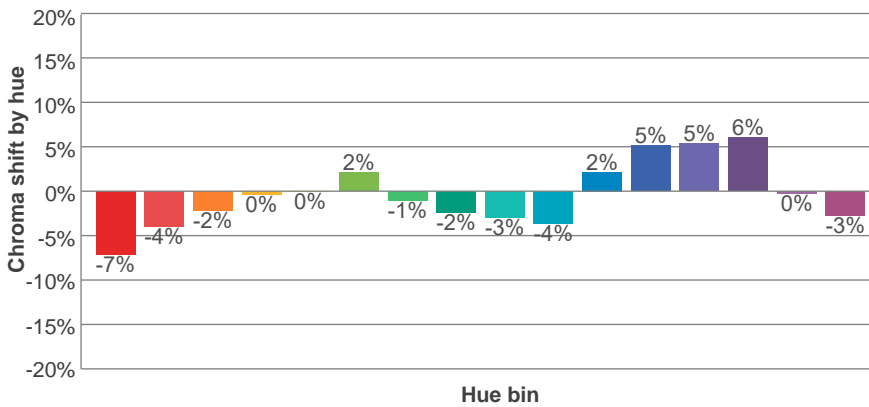
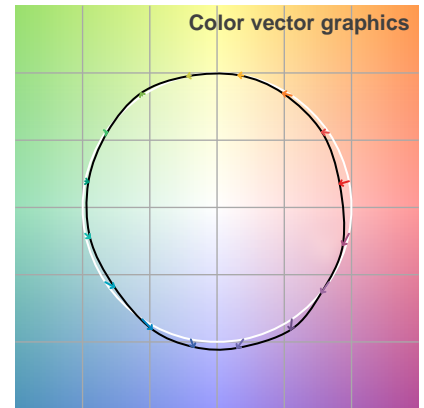
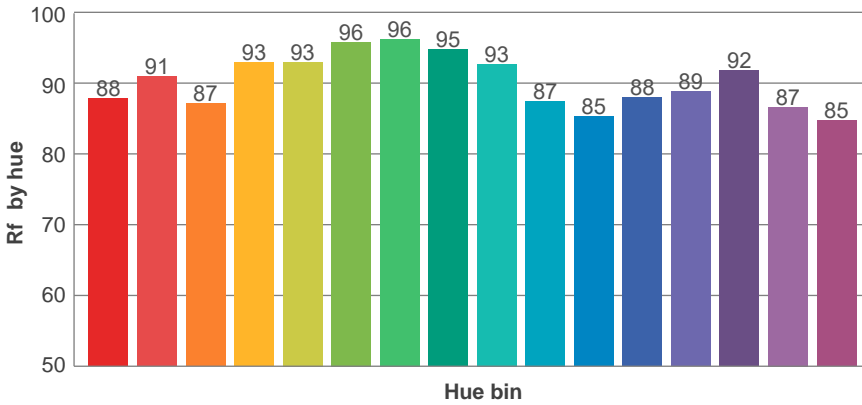
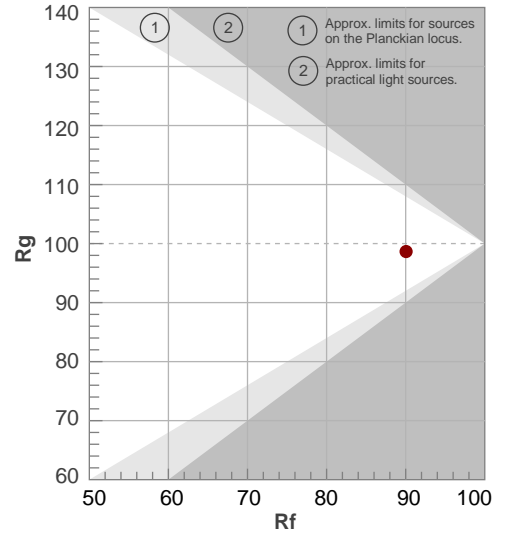

Beam details

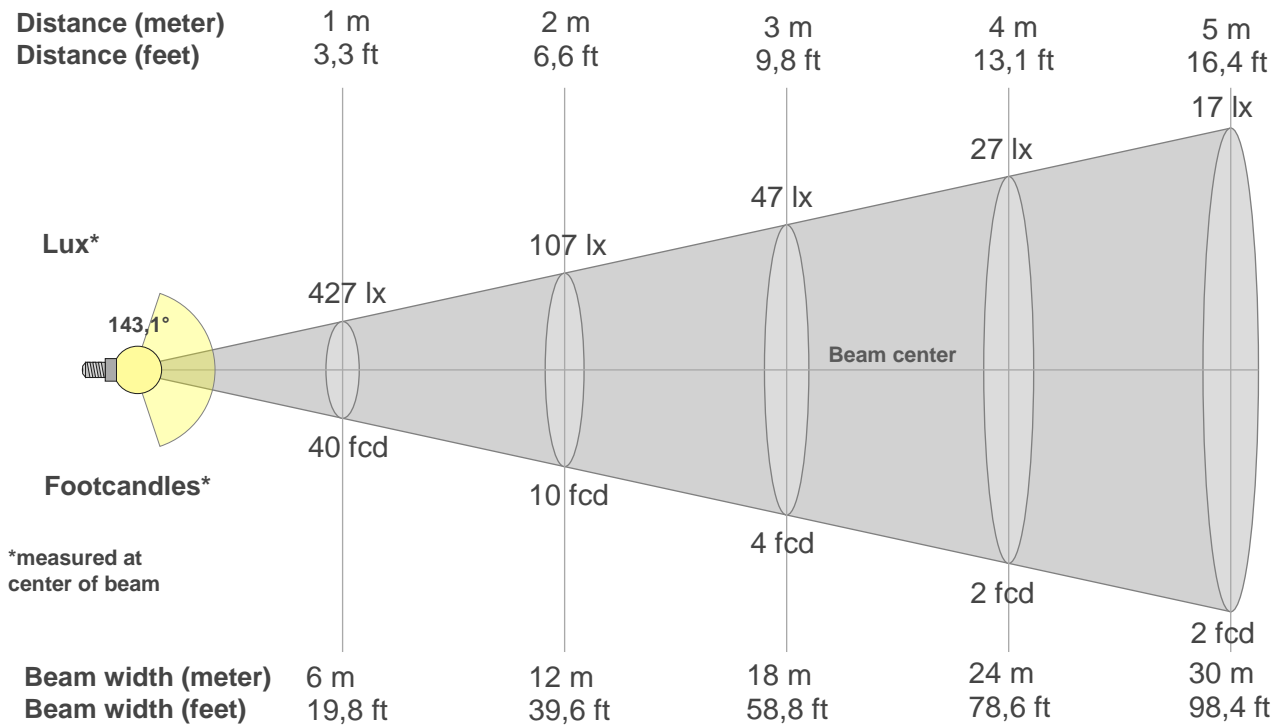

Beam intensities from 1-20m

{BEAM_INT_TABLE_START}

m	m	m	m	m	m	m	m	m	m	m	m	m	m	m	m	m	m	m	m	m
ft	ft	ft	ft	ft	ft	ft	ft	ft	ft	ft	ft	ft	ft	ft	ft	ft	ft	ft	ft	ft
lx	lx	lx	lx	lx	lx	lx	lx	lx	lx	lx	lx	lx	lx	lx	lx	lx	lx	lx	lx	lx
fcd	fcd	fcd	fcd	fcd	fcd	fcd	fcd	fcd	fcd	fcd	fcd	fcd	fcd	fcd	fcd	fcd	fcd	fcd	fcd	fcd

Intensities in 0° c-plane

0°	5°	10°	15°	20°	25°	30°	35°	40°	45°	50°	55°	60°	65°	70°	75°	80°	85°	90°	95°
427	425	425	424	425	426	423	413	393	368	338	309	281	254	227	161	54	8	5	4
100%	100%	100%	99%	100%	100%	99%	97%	92%	86%	79%	72%	66%	60%	53%	38%	13%	2%	1%	1%

Intensities in 90° c-plane

0°	5°	10°	15°	20°	25°	30°	35°	40°	45°	50°	55°	60°	65°	70°	75°	80°	85°	90°	95°
427	430	430	429	430	431	428	417	398	372	342	312	284	257	229	159	53	8	5	4
100%	101%	101%	101%	101%	101%	100%	98%	93%	87%	80%	73%	66%	60%	54%	37%	12%	2%	1%	1%

Intensities in 180° c-plane

0°	5°	10°	15°	20°	25°	30°	35°	40°	45°	50°	55°	60°	65°	70°	75°	80°	85°	90°	95°
427	425	425	424	425	426	423	413	393	368	338	309	281	254	227	161	54	8	5	4
100%	100%	100%	99%	100%	100%	99%	97%	92%	86%	79%	72%	66%	60%	53%	38%	13%	2%	1%	1%

Intensities in 270° c-plane

0°	5°	10°	15°	20°	25°	30°	35°	40°	45°	50°	55°	60°	65°	70°	75°	80°	85°	90°	95°
427	430	430	429	430	431	428	417	398	372	342	312	284	257	229	159	53	8	5	4
100%	101%	101%	101%	101%	101%	100%	98%	93%	87%	80%	73%	66%	60%	54%	37%	12%	2%	1%	1%

Beam angle 50%	Field angle 10%	Cutoff angle 2,5%	Intensity ratio in 120° cone	Intensity ratio in 90° cone
143,1°	161,2°	167°	72,6%	46,7%

UGR

Glare Evaluation According to UGR

p Ceiling	70	70	50	50	30	70	70	50	50	30	
p Walls	50	30	50	30	30	50	30	50	30	30	
p Floor	20	20	20	20	20	20	20	20	20	20	
Room size X Y	Viewing direction at right angles to lamp axis					Viewing direction parallel to lamp axis					
2H	2H	26,8	28,1	27,1	28,4	28,7	26,8	28,1	27,1	28,5	28,7
	3H	29,0	30,4	29,5	30,7	30,9	29,1	30,4	29,5	30,7	31,0
	4H	30,0	31,3	30,4	31,6	31,9	30,0	31,3	30,5	31,6	31,9
	6H	30,4	31,5	30,7	31,8	32,2	30,4	31,5	30,8	31,8	32,2
	8H	30,4	31,5	30,8	31,8	32,2	30,4	31,5	30,8	31,8	32,3
4H	12H	30,3	31,4	30,7	31,8	32,2	30,4	31,4	30,7	31,8	32,2
	2H	27,6	28,9	28,1	29,2	29,5	27,7	28,9	28,1	29,2	29,5
	3H	30,2	31,3	30,6	31,6	32,1	30,3	31,3	30,6	31,7	32,1
	4H	31,2	32,2	31,6	32,6	33,2	31,2	32,2	31,7	32,6	33,2
	6H	31,5	32,5	32,1	32,8	33,2	31,5	32,5	32,1	32,8	33,2
8H	8H	31,6	32,4	32,1	32,8	33,2	31,5	32,4	32,1	32,8	33,2
	12H	31,5	32,2	32,0	32,7	33,2	31,5	32,2	32,0	32,7	33,2
	4H	31,5	32,4	32,0	32,7	33,1	31,5	32,4	32,0	32,8	33,2
	6H	31,9	32,6	32,5	33,1	33,6	31,9	32,6	32,5	33,1	33,6
	8H	32,0	32,5	32,5	33,1	33,7	32,0	32,5	32,5	33,1	33,7
12H	12H	32,0	32,4	32,5	32,9	33,6	31,9	32,4	32,5	32,9	33,6
	4H	31,5	32,2	32,0	32,6	33,1	31,5	32,2	32,0	32,7	33,2
	6H	32,0	32,5	32,5	33,0	33,7	31,9	32,5	32,5	33,0	33,7
	8H	32,0	32,4	32,6	33,0	33,6	32,0	32,4	32,6	33,0	33,6
	Variation of the observer position for the luminaire distance S										
S = 1.0H	0,1 / -0,1					0,1 / -0,1					
S = 1.5H	0,1 / -0,2					0,1 / -0,2					
S = 2.0H	0,3 / -0,4					0,3 / -0,4					
Standard table	n/a					n/a					
Correction summand	n/a					n/a					
Corrected glare indices referring to 1624 lm total luminous flux											

Light planning

Coefficients of Utilization

Ceiling reflectance	80				70				50			30			10			0			
Wall reflectance	70	50	30	10	70	50	30	10	50	30	10	50	30	10	50	30	10	0			
Floor reflectance	20	20	20	20	20	20	20	20	20	20	20	20	20	20	20	20	20	20	20	20	0
RCR	(RCR: Room Cavity Ratio)																				
	Room Values are expressed as percentage of Lumens delivered to the task surface																				
0	119	119	119	119	116	116	116	116	111	111	111	106	106	106	101	101	101	99			
1	108	103	98	94	105	100	96	93	96	93	89	92	89	86	88	86	84	81			
2	97	88	81	75	94	86	80	74	82	77	72	79	74	70	76	72	68	66			
3	88	77	68	61	85	75	67	60	72	65	59	69	63	58	66	61	57	54			
4	80	67	58	51	77	66	57	50	63	55	49	60	54	49	58	52	48	45			
5	73	59	50	43	71	58	49	43	56	48	42	54	47	41	52	46	41	39			
6	67	53	44	37	65	52	43	37	50	42	36	48	41	36	47	40	35	33			
7	62	48	39	32	60	47	38	32	45	37	32	44	37	31	42	36	31	29			
8	58	43	35	28	56	43	34	28	41	34	28	40	33	28	39	32	28	26			
9	54	40	31	25	52	39	31	25	38	30	25	37	30	25	36	29	25	23			
10	50	37	28	23	49	36	28	23	35	28	23	34	27	22	33	27	22	20			

LAMPS (number of lamps)

Luminaire budgetary diagram

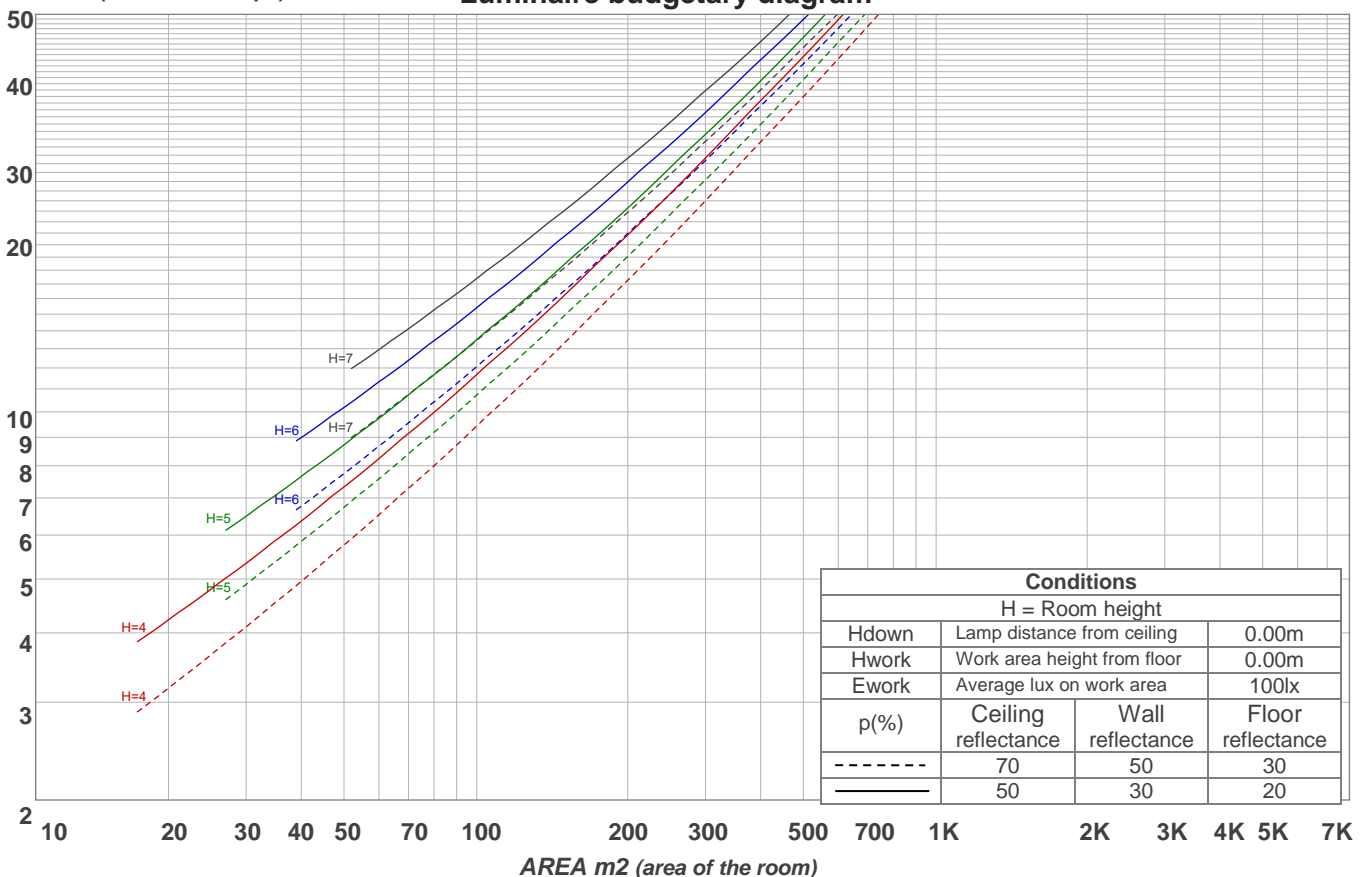

Zonal Lumen Summary

0°-10°	10°-20°	20°-30°	30°-40°	40°-50°	50°-60°	60°-70°	70°-80°	80°-90°
40,7 lm	121 lm	198 lm	259 lm	285 lm	278 lm	253 lm	160 lm	15,1 lm
90°-100°	100°-110°	110°-120°	120°-130°	130°-140°	140°-150°	150°-160°	160°-170°	170°-180°
4,00 lm	2,29 lm	2,21 lm	2,15 lm	1,98 lm	1,73 lm	1,34 lm	0,866 lm	0,296 lm

Stabilization

Warmup curve

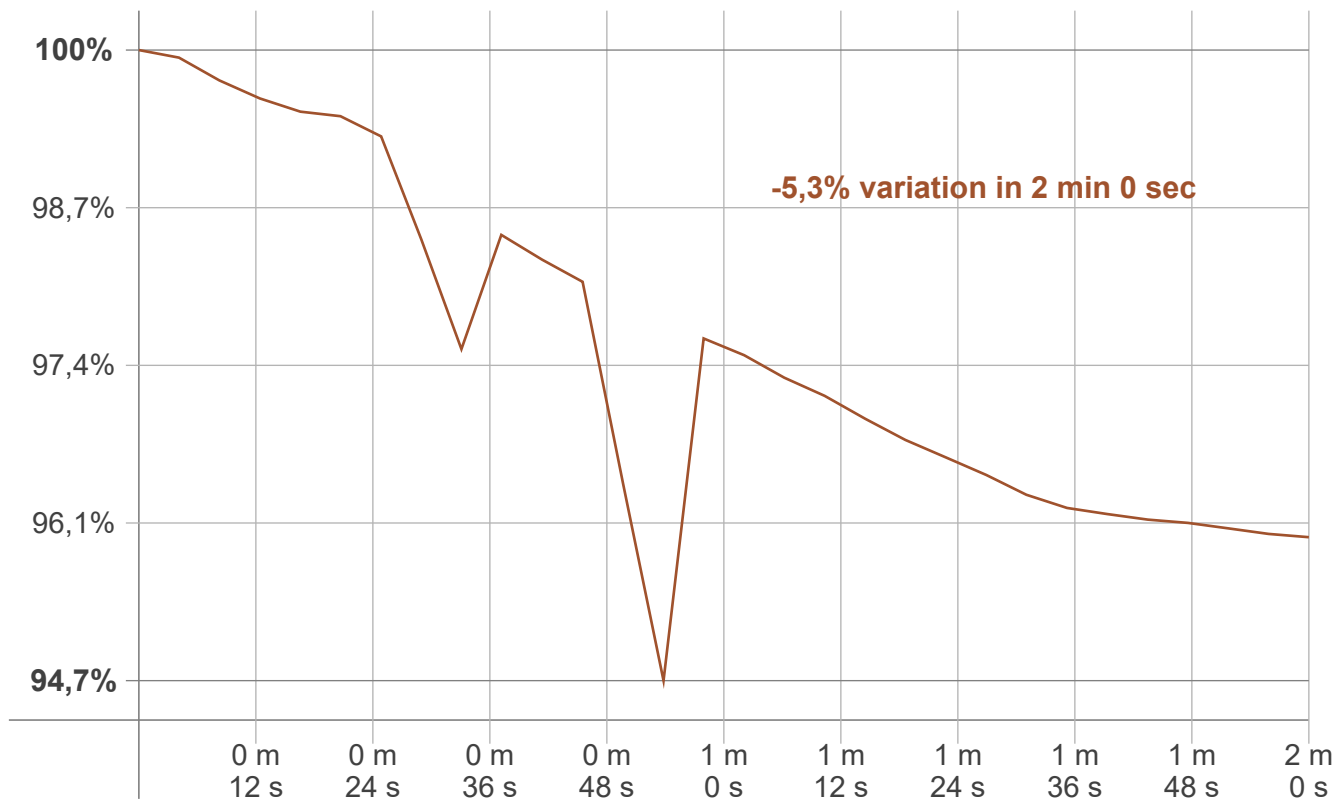

Warmup result

Warmup time:	Lamp stabilized in 2 min 0 sec
Warmup variation	-5,3%

Warmup conditions

Stable period:	2 min
Stable change max:	500,0%
Minimum time:	2 min

Color temperature change

CCT start	CCT change	CCT end
3890 K	+15 K	3905 K

Output change

Output start	Output change	Output end
375 lm	-50 lm	325 lm