

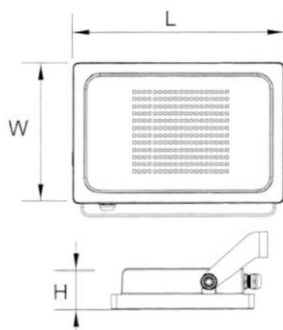

Dimensiones (mm)

**Largo (L): 120; Ancho (W): 90
Alto (H): 30.**



Código

ERIS-20W-3K

Descripción

Luminaria tipo reflector diseñada con módulo de LED (DOB). Para anclar en piso, poste o muro por medio del sujetador ubicado en la parte trasera. Compuesta en la parte interna por una pantalla blanca y un difusor en vidrio templado.



Materiales y acabado

Cuerpo en termoplástico (PA) inyectado. Sujetador fabricado en lámina de hierro, con acabado en pintura poliéster electrostática en polvo.

Color

Negra.

Características técnicas

LED	 115°	 30,000h	IP 65	IK 06
PF 0,92	THD <50%	Hz 50/60	V 100-265	

Fuente de luz

Módulo de LED.

Potencia Nominal CRI K Lm / W Lm de Salida

20W >70 3000 113 2059

Características de fuente de luz

- Color temperatura disponible 3000K (cálido).
- “DOB”, Driver on board.
- Potencia de Salida: 18,2W.

Instalación

Se debe tener en cuenta la alimentación de la luminaria, para ubicarla.

1. Instale los soportes.
 2. Afloje los pernos a ambos lados del soporte.
 3. Ajuste el ángulo del reflector.
 4. Apriete los pernos a ambos lados del soporte.
 5. Conecte el cableado del reflector.
- Encienda la alimentación para asegurarse de que el reflector funcione.

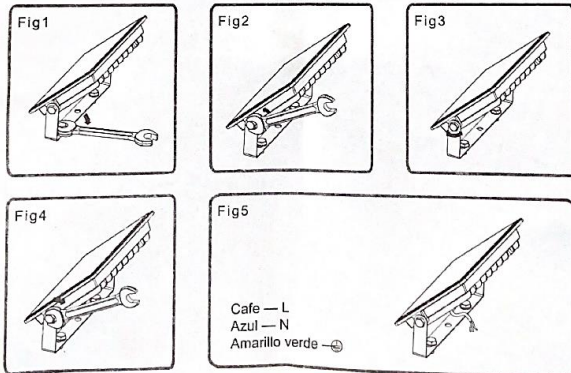

Nota: Distecsa garantiza el buen y correcto funcionamiento del sistema eléctrico antes de ser instalado, algún retroceso o falla en el sistema corre por parte del personal de instalación.

Mantenimiento de las luminarias

Es esencial llevar a cabo periódicamente inspecciones y mantenimiento a las luminarias instaladas, ya que estas reciben influencia de las condiciones de operación y del medio donde se ubican.

1. Mantenimiento correctivo

El mantenimiento correctivo de las luminarias consiste en localizar, reparar y adecuar las instalaciones para que funcionen el máximo número de horas posible, con el desempeño para el que fueron diseñadas.

Las actividades que componen el mantenimiento correctivo son:

- Localización y reparación de averías
- Adecuación de instalaciones

Para la ejecución del mantenimiento correctivo es importante tener en cuenta los siguientes aspectos:

- Si se genera algún inconveniente en la regleta LED por favor comunicarse con la empresa.
- Revisar el encendido, apagado y el correcto funcionamiento de la luminaria.
- Limpiar las regletas LED y el conjunto óptico de las luminarias con aire comprimido. Para manipular la luminaria se recomienda utilizar guantes quirúrgicos.

2. Mantenimiento preventivo

Dentro de las técnicas de diagnóstico se deben considerar las mediciones eléctricas en diferentes puntos de la red, así como la medición de parámetros eléctricos de operación de las luminarias y sus componentes.

3. Mantenimiento de las instalaciones eléctricas de las luminarias

La persona encargada de la operación y el mantenimiento de las instalaciones eléctricas de las luminarias será responsable de mantenerlas en condiciones seguras, por lo tanto deben garantizar que se cumplan las disposiciones del reglamento que establece los requisitos que deben cumplir los sistemas de alumbrado y verificar que estas conexiones no presenten ningún riesgo para la salud o la vida de las personas, animales o el medio ambiente.

Light efficiency:



Light quality:



Color temperature:



Output: 2059 lm

Peak: 756 cd

Power: 18,2 W

PF: 0,92



Product name:
E0549-ERIS-20W-3K

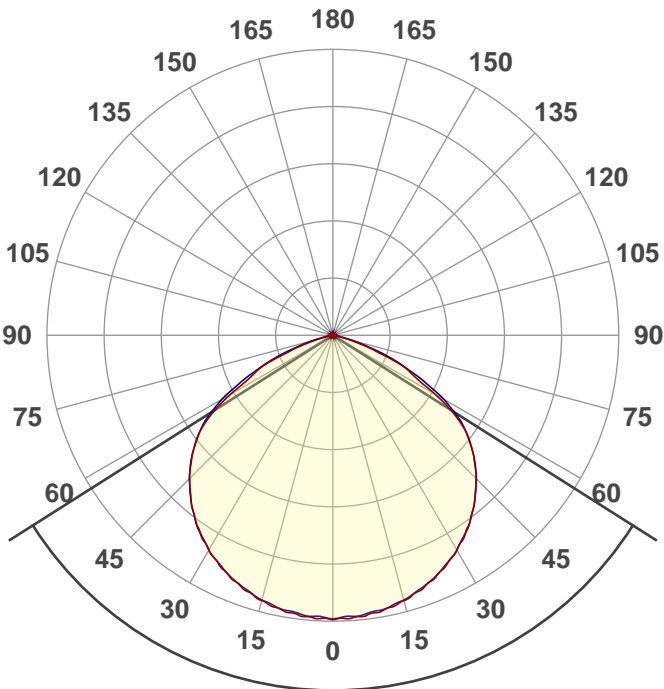

Beam angle **115,3°**



CIE 1931
x: 0,439
y: 0,404

THD Values:

Voltage: 2,53%

Current: 40,34%

Spectra

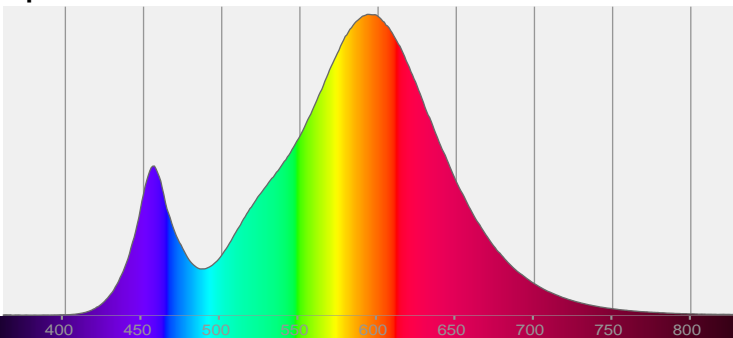

Power



Voltage: 114 V
Current: 0,174 A
Frequency: 60 Hz

ISO Diagrams

ISO lux diagram

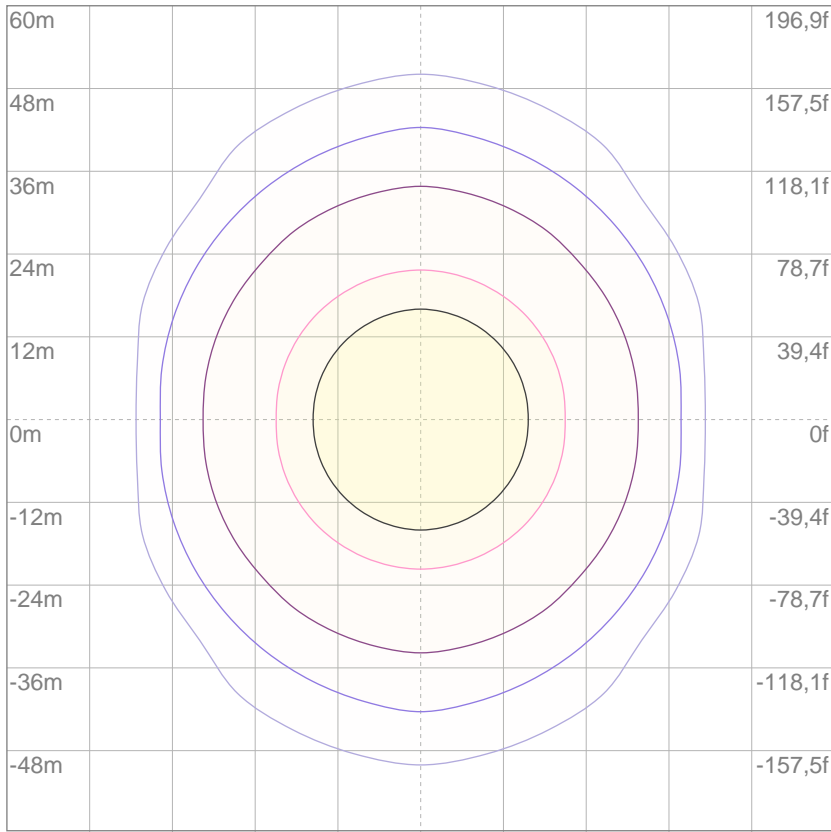

3%	0,226 lx
5%	0,377 lx
10%	0,755 lx
30%	2,26 lx
50%	3,77 lx

Conditions:
 Number of c-planes: 4
 Lux at center: 7,55 lx

Lux distribution on a surface when lamp is mounted at 10 meters from the surface.

Mounting height: 10 meters (33 f)

Color details

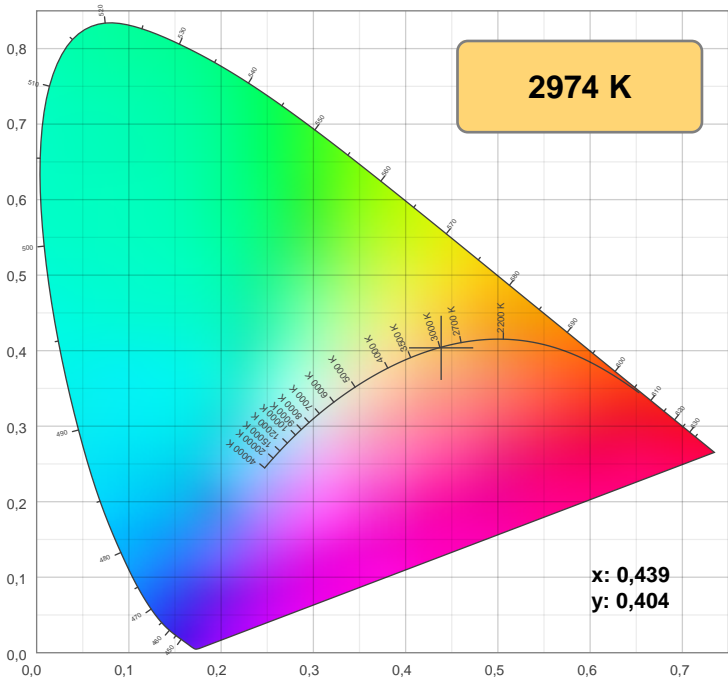

CIE 1931

CRI: 72,1 (R1-R8)

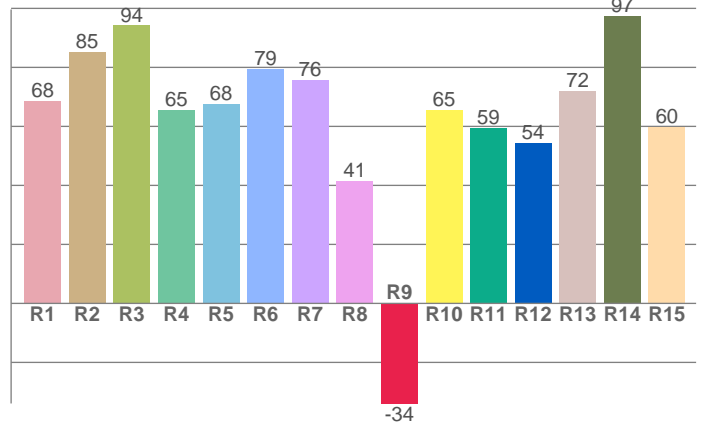

CRI R values, only R1-R8 are used to calculate final CRI value

R1	R2	R3	R4	R5	R6	R7	R8	R9	R10	R11	R12	R13	R14	R15
68,5	85,0	94,2	65,5	67,7	79,4	75,7	41,3	-33,9	65,5	59,4	54,5	72,1	97,3	59,9

Color parameters

Color temperature	Color rendering index	Red component	Color fidelity	Color gamut	Color quality scale	Color coordinate cie 1931	Color coordinate cie 1931	Color coordinate	Color coordinate	Color deviation from black body
CCT	CRI	CRI R9	TM30 Rf	TM30 Rg	CQS	x	y	u	v	Δuv
2974 K	72,1	-33,9	76,5	91,0	71,9	0,439	0,404	0,252	0,348	-0,0004

TM-30 details

Rf 76,5
Fidelity index Rf

Rg 91,0
Gamut index Rg

Hue Bin	R _f	Shifts (%)	
		Chroma	Hue
1	69	-17%	0%
2	70	-13%	11%
3	66	-5%	17%
4	83	0%	10%
5	90	4%	5%
6	90	2%	-5%
7	80	-8%	-10%
8	83	-10%	-2%
9	78	-12%	7%
10	69	-9%	19%
11	70	-2%	22%
12	79	8%	8%
13	86	7%	-7%
14	75	7%	-19%
15	77	-4%	-14%
16	68	-13%	-22%

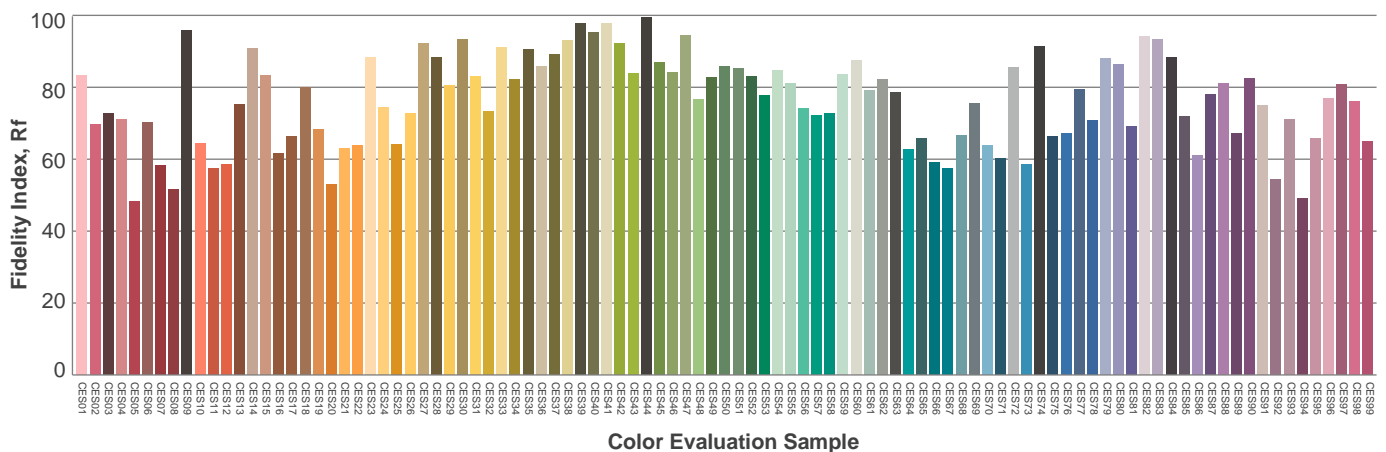
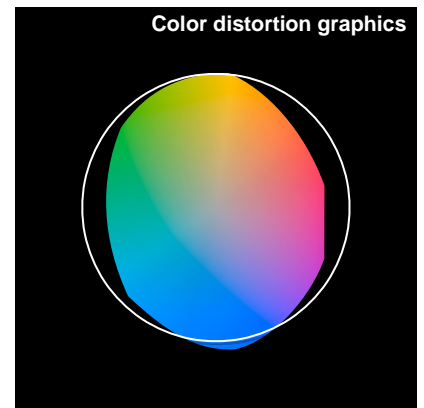
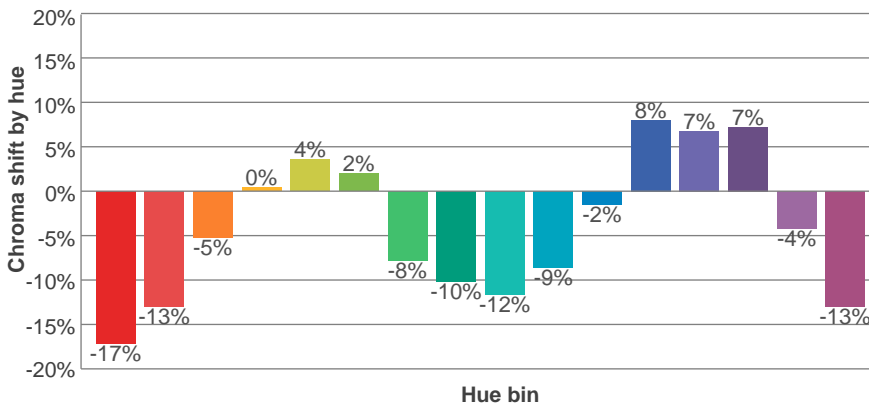
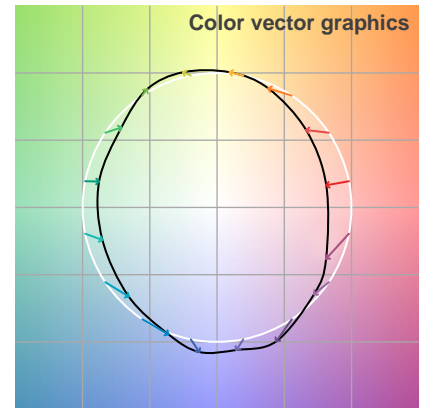
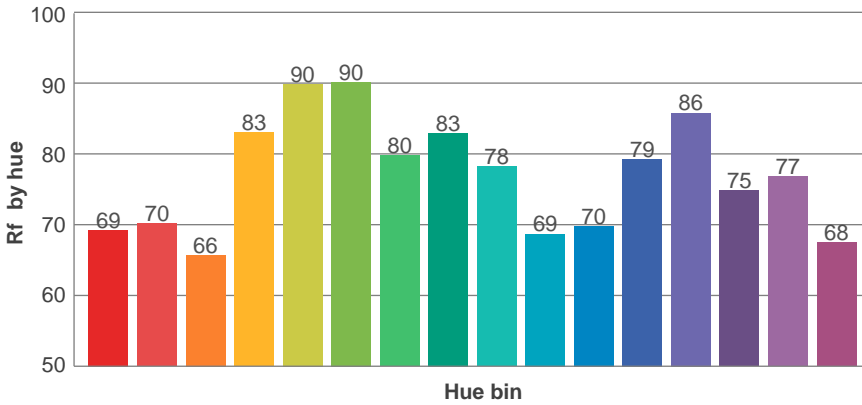
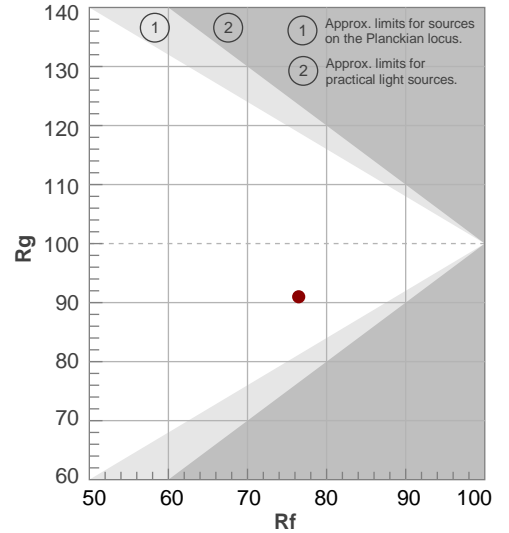

Beam details

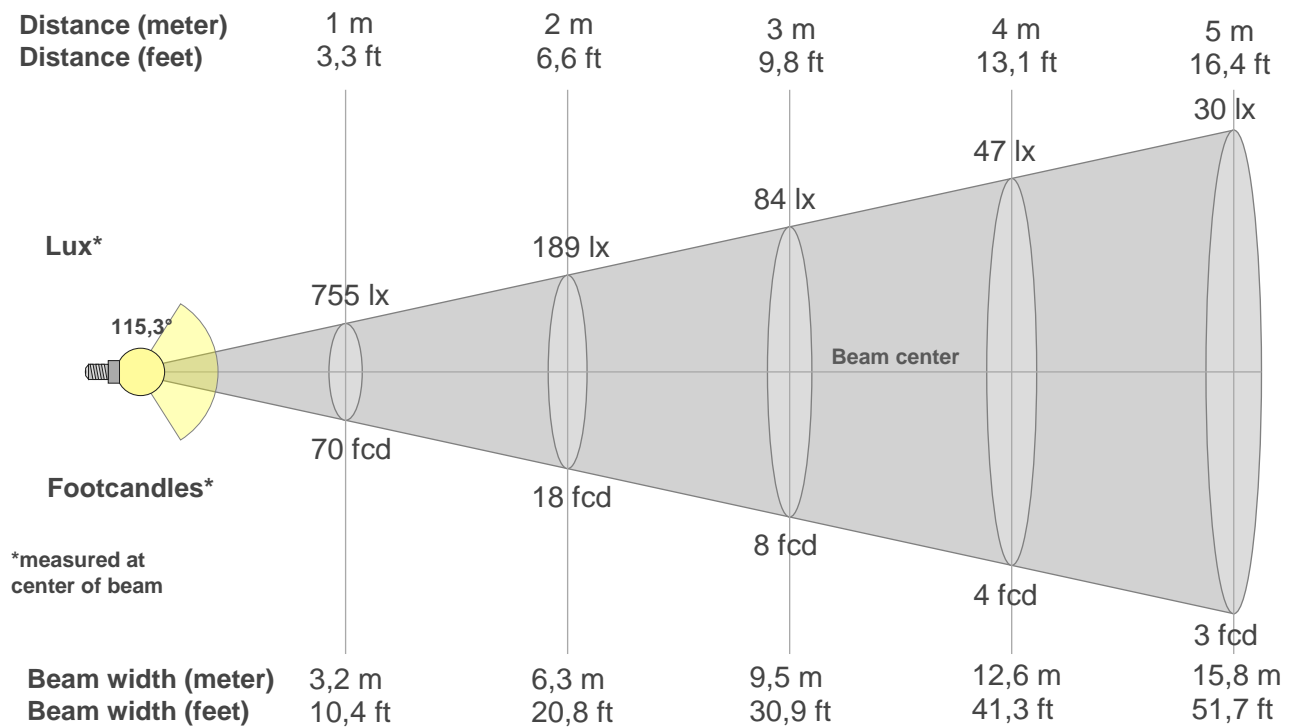

Beam intensities from 1-20m

1m	2m	3m	4m	5m	6m	7m	8m	9m	10m	11m	12m	13m	14m	15m	16m	17m	18m	19m	20m
3,3ft	6,6ft	9,8ft	13,1ft	16,4ft	19,7ft	23ft	26,2ft	29,5ft	32,8ft	36,1ft	39,4ft	42,7ft	45,9ft	49,2ft	52,5ft	55,8ft	59,1ft	62,3ft	65,6ft
755lx	189lx	84lx	47lx	30lx	21lx	15lx	12lx	9lx	8lx	6lx	5lx	4lx	4lx	3lx	3lx	3lx	2lx	2lx	2lx
70,1fcd	17,5fcd	7,8fcd	4,4fcd	2,8fcd	1,9fcd	1,4fcd	1,1fcd	0,9fcd	0,7fcd	0,6fcd	0,5fcd	0,4fcd	0,4fcd	0,3fcd	0,3fcd	0,2fcd	0,2fcd	0,2fcd	0,2fcd

Intensities in 0° c-plane

0°	5°	10°	15°	20°	25°	30°	35°	40°	45°	50°	55°	60°	65°	70°	75°	80°	85°	90°	95°
755	752	745	731	712	688	660	625	585	539	487	422	314	221	117	40	11	2	0	0
100%	100%	99%	97%	94%	91%	87%	83%	78%	71%	64%	56%	42%	29%	16%	5%	1%	0%	0%	0%

Intensities in 90° c-plane

0°	5°	10°	15°	20°	25°	30°	35°	40°	45°	50°	55°	60°	65°	70°	75°	80°	85°	90°	95°
755	750	742	729	710	687	660	626	585	540	487	425	341	232	137	58	15	1	0	0
100%	99%	98%	97%	94%	91%	87%	83%	78%	71%	64%	56%	45%	31%	18%	8%	2%	0%	0%	0%

Intensities in 180° c-plane

0°	5°	10°	15°	20°	25°	30°	35°	40°	45°	50°	55°	60°	65°	70°	75°	80°	85°	90°	95°
755	752	745	731	712	688	660	625	585	539	487	422	314	221	117	40	11	2	0	0
100%	100%	99%	97%	94%	91%	87%	83%	78%	71%	64%	56%	42%	29%	16%	5%	1%	0%	0%	0%

Intensities in 270° c-plane

0°	5°	10°	15°	20°	25°	30°	35°	40°	45°	50°	55°	60°	65°	70°	75°	80°	85°	90°	95°
755	750	742	729	710	687	660	626	585	540	487	425	341	232	137	58	15	1	0	0
100%	99%	98%	97%	94%	91%	87%	83%	78%	71%	64%	56%	45%	31%	18%	8%	2%	0%	0%	0%

Beam angle 50%	Field angle 10%	Cutoff angle 2,5%	Intensity ratio in 120° cone	Intensity ratio in 90° cone
115,3°	146°	156,4°	86,2%	58,0%

UGR

Glare Evaluation According to UGR

p Ceiling	70	70	50	50	30	70	70	50	50	30	
p Walls	50	30	50	30	30	50	30	50	30	30	
p Floor	20	20	20	20	20	20	20	20	20	20	
Room size X Y	Viewing direction at right angles to lamp axis					Viewing direction parallel to lamp axis					
2H	2H	27,3	28,5	27,5	28,8	29,0	27,5	28,6	27,7	28,9	29,1
	3H	27,9	29,1	28,4	29,4	29,6	28,2	29,4	28,6	29,6	29,8
	4H	28,0	29,1	28,4	29,4	29,7	28,3	29,4	28,7	29,7	29,9
	6H	28,0	29,0	28,3	29,3	29,6	28,3	29,3	28,6	29,6	30,0
	8H	28,0	28,9	28,3	29,2	29,6	28,3	29,2	28,6	29,5	29,9
4H	12H	27,9	28,8	28,3	29,2	29,6	28,2	29,1	28,6	29,5	29,9
	2H	27,7	28,8	28,1	29,1	29,4	27,8	29,0	28,2	29,2	29,5
	3H	28,6	29,5	29,0	29,8	30,3	28,8	29,7	29,2	30,0	30,5
	4H	28,6	29,4	29,0	29,8	30,4	28,8	29,7	29,3	30,1	30,6
	6H	28,5	29,3	29,0	29,7	30,1	28,8	29,6	29,3	30,0	30,4
8H	8H	28,5	29,2	29,0	29,6	30,0	28,8	29,5	29,3	29,9	30,3
	12H	28,5	29,1	29,0	29,5	30,0	28,7	29,4	29,2	29,8	30,2
	4H	28,6	29,3	29,1	29,7	30,0	28,8	29,6	29,3	29,9	30,3
	6H	28,6	29,1	29,1	29,6	30,1	28,8	29,4	29,3	29,8	30,4
	8H	28,6	29,0	29,1	29,5	30,2	28,8	29,3	29,3	29,8	30,5
12H	12H	28,5	28,9	29,1	29,4	30,0	28,8	29,2	29,4	29,7	30,3
	4H	28,5	29,1	29,0	29,5	30,0	28,8	29,4	29,3	29,8	30,3
	6H	28,5	29,0	29,1	29,5	30,2	28,8	29,3	29,3	29,8	30,4
8H	28,5	28,9	29,1	29,4	30,0	28,8	29,2	29,4	29,7	30,3	
Variation of the observer position for the luminaire distance S											
S = 1.0H	0,2 / -0,2					0,1 / -0,2					
S = 1.5H	0,6 / -1,1					0,5 / -0,7					
S = 2.0H	1,6 / -2,3					1,4 / -2,1					
Standard table	n/a					n/a					
Correction summand	n/a					n/a					
Corrected glare indices referring to 2059 lm total luminous flux											

Light planning

Coefficients of Utilization

Ceiling reflectance	80				70				50			30			10			0			
Wall reflectance	70	50	30	10	70	50	30	10	50	30	10	50	30	10	50	30	10	0			
Floor reflectance	20	20	20	20	20	20	20	20	20	20	20	20	20	20	20	20	20	20	20	20	0
RCR	(RCR: Room Cavity Ratio)																				
	Room Values are expressed as percentage of Lumens delivered to the task surface																				
0	119	119	119	119	116	116	116	116	111	111	111	106	106	106	102	102	102	100			
1	110	106	102	99	108	104	100	97	100	97	94	96	93	91	92	90	89	87			
2	101	93	87	82	98	91	86	81	88	83	79	85	81	77	82	78	76	73			
3	92	82	75	69	90	81	74	68	78	72	67	75	70	66	73	68	65	62			
4	85	73	65	58	82	72	64	58	69	63	57	67	61	56	65	60	56	54			
5	78	65	57	50	76	64	56	50	62	55	49	60	54	49	58	53	48	46			
6	72	59	50	44	70	58	50	44	56	49	43	54	48	43	53	47	43	41			
7	66	53	45	39	65	52	44	39	51	44	38	49	43	38	48	42	38	36			
8	62	49	40	34	60	48	40	34	47	39	34	45	39	34	44	38	34	32			
9	58	44	36	31	56	44	36	31	43	36	31	42	35	31	41	35	30	29			
10	54	41	33	28	53	40	33	28	39	33	28	39	32	28	38	32	28	26			

LAMPS (number of lamps)

Luminaire budgetary diagram

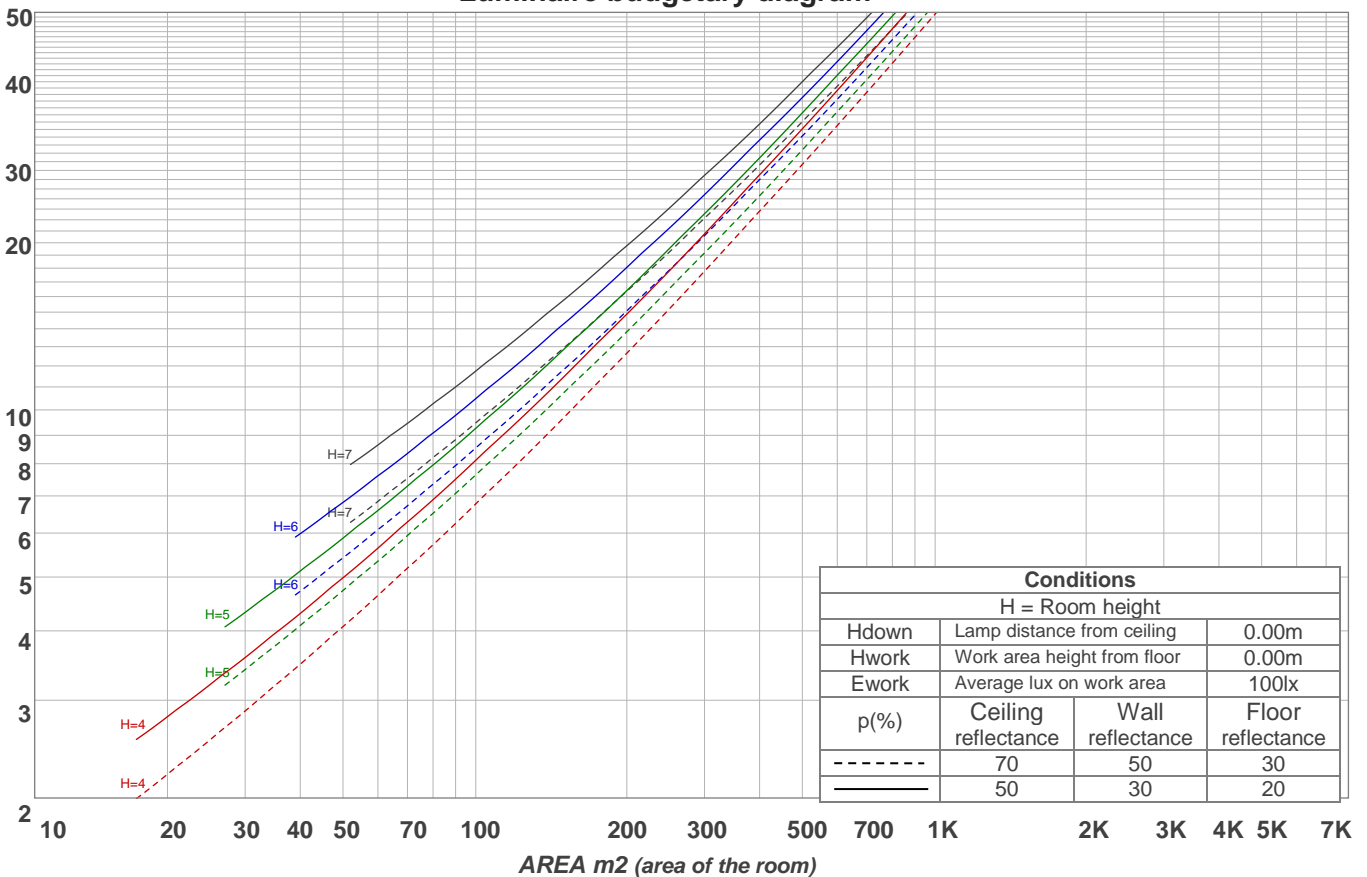

Zonal Lumen Summary

0°-10°	10°-20°	20°-30°	30°-40°	40°-50°	50°-60°	60°-70°	70°-80°	80°-90°
71,4 lm	206 lm	317 lm	391 lm	415 lm	373 lm	222 lm	58,3 lm	3,20 lm
90°-100°	100°-110°	110°-120°	120°-130°	130°-140°	140°-150°	150°-160°	160°-170°	170°-180°
0,069 lm	0,058 lm	0,077 lm	0,082 lm	0,075 lm	0,063 lm	0,042 lm	0,024 lm	0,006 lm

Road report

LCS table

BUG rating:	B1 U1 G0	
Forward light	Lumens	Lumens %
Low(0-30):	297,3	14,4%
Medium(30-60):	589,6	28,6%
High(60-80):	140,5	6,8%
Very high(80-90):	1,7	0,1%
Back light		
Low(0-30):	297,3	14,4%
Medium(30-60):	589,6	28,6%
High(60-80):	140,5	6,8%
Very high(80-90):	1,7	0,1%
Uplight		
Low(90-100):	0,1	0%
High(100-180):	0,4	0%

LCS graph

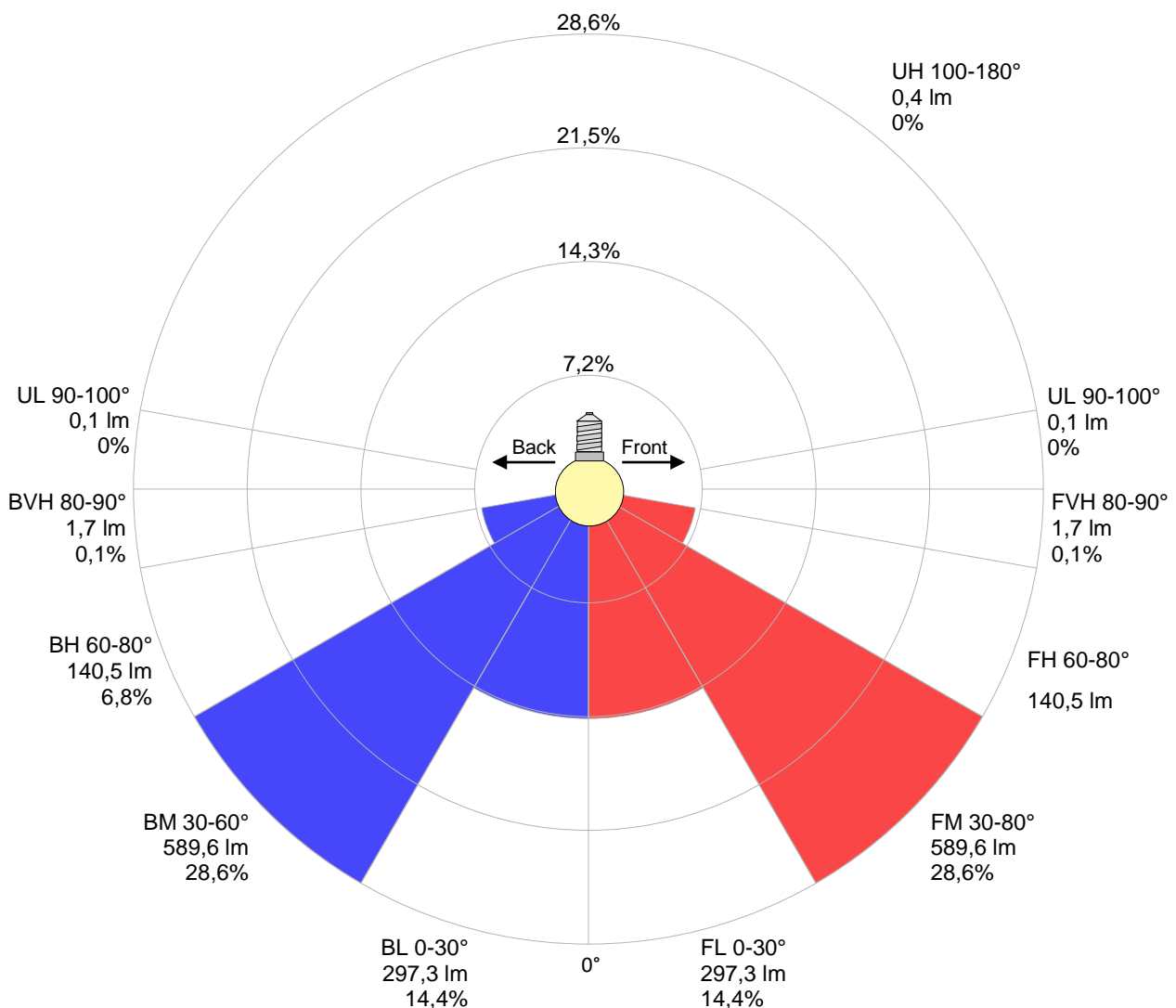

Stabilization

Warmup curve

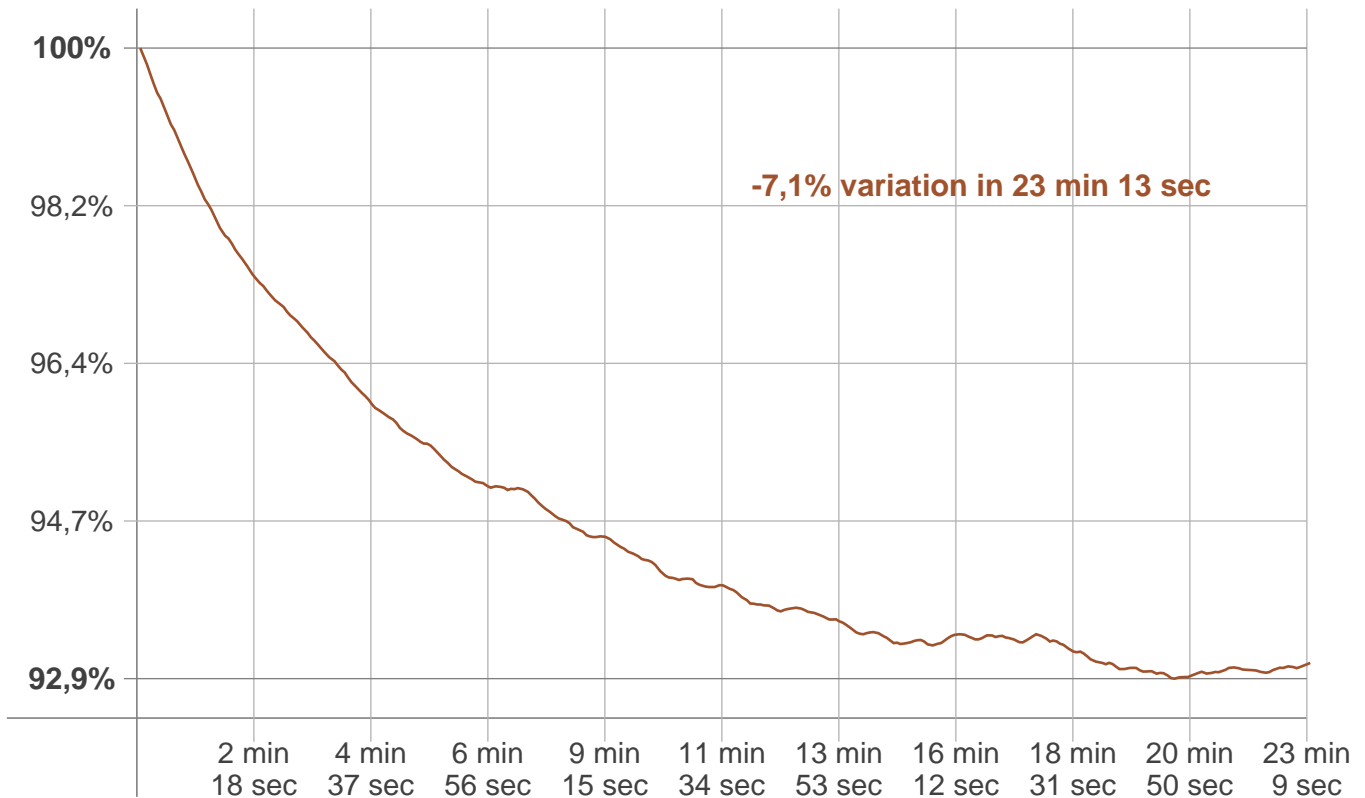

Warmup result

Warmup time:	23 min 13 sec
Warmup variation	-7,2%

Warmup conditions

Stable period:	15 min
Stable change max:	2,0%
Minimum time:	15 min

Color temperature change

CCT start	CCT change	CCT end
2945 K	+29 K	2974 K

Output change

Output start	Output change	Output end
2206 lm	-148 lm	2059 lm