

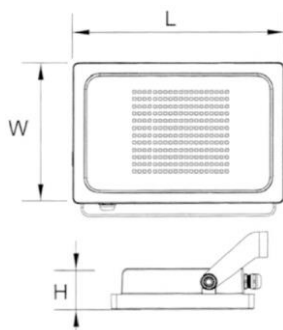

Dimensiones (mm)

**Largo (L): 150; Ancho (W): 110
Alto (H): 30.**



Código

ERIS-30W-5K

Descripción

Luminaria tipo reflector diseñada con módulo de LED (DOB). Para anclar en piso, poste o muro por medio del sujetador ubicado en la parte trasera. Compuesta en la parte interna por una pantalla blanca y un difusor en vidrio templado.



Materiales y acabado

Cuerpo en termoplástico (PA) inyectado. Sujetador fabricado en lámina de hierro, con acabado en pintura poliéster electrostática en polvo.

Color

Negra.

Características técnicas

LED	 118°	 30,000h	IP 65	IK 06
PF 0,92	THD <50%	Hz 50/60	V 100-265	

Fuente de luz

Módulo de LED.

Potencia Nominal CRI K Lm / W Lm de Salida

50W >70 5000 97 2604

Características de fuente de luz

- Color temperatura disponible 5000K (luz día).
- “DOB”, Driver on board.
- Potencia de Salida: 26,9W.

Instalación

Se debe tener en cuenta la alimentación de la luminaria, para ubicarla.

1. Instale los soportes.
2. Afloje los pernos a ambos lados del soporte.
3. Ajuste el ángulo del reflector.
4. Apriete los pernos a ambos lados del soporte.
5. Conecte el cableado del reflector.
Encienda la alimentación para asegurarse de que el reflector funcione.

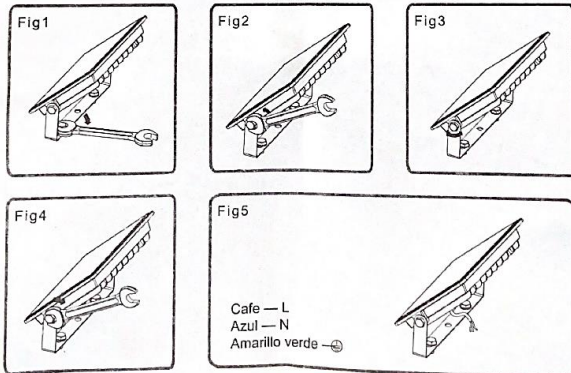

Nota: Distecsa garantiza el buen y correcto funcionamiento del sistema eléctrico antes de ser instalado, algún retroceso o falla en el sistema corre por parte del personal de instalación.

Mantenimiento de las luminarias

Es esencial llevar a cabo periódicamente inspecciones y mantenimiento a las luminarias instaladas, ya que estas reciben influencia de las condiciones de operación y del medio donde se ubican.

1. Mantenimiento correctivo

El mantenimiento correctivo de las luminarias consiste en localizar, reparar y adecuar las instalaciones para que funcionen el máximo número de horas posible, con el desempeño para el que fueron diseñadas.

Las actividades que componen el mantenimiento correctivo son:

- Localización y reparación de averías
- Adecuación de instalaciones

Para la ejecución del mantenimiento correctivo es importante tener en cuenta los siguientes aspectos:

- Si se genera algún inconveniente en la regleta LED por favor comunicarse con la empresa.
- Revisar el encendido, apagado y el correcto funcionamiento de la luminaria.
- Limpiar las regletas LED y el conjunto óptico de las luminarias con aire comprimido. Para manipular la luminaria se recomienda utilizar guantes quirúrgicos.

2. Mantenimiento preventivo

Dentro de las técnicas de diagnóstico se deben considerar las mediciones eléctricas en diferentes puntos de la red, así como la medición de parámetros eléctricos de operación de las luminarias y sus componentes.

3. Mantenimiento de las instalaciones eléctricas de las luminarias

La persona encargada de la operación y el mantenimiento de las instalaciones eléctricas de las luminarias será responsable de mantenerlas en condiciones seguras, por lo tanto deben garantizar que se cumplan las disposiciones del reglamento que establece los requisitos que deben cumplir los sistemas de alumbrado y verificar que estas conexiones no presenten ningún riesgo para la salud o la vida de las personas, animales o el medio ambiente.

Light efficiency:



Light quality:



Color temperature:



Output: 2604 lm

Peak: 893 cd

Power: 26,9 W

PF: 0,92



Product name:
E0552-ERIS-30W-5K

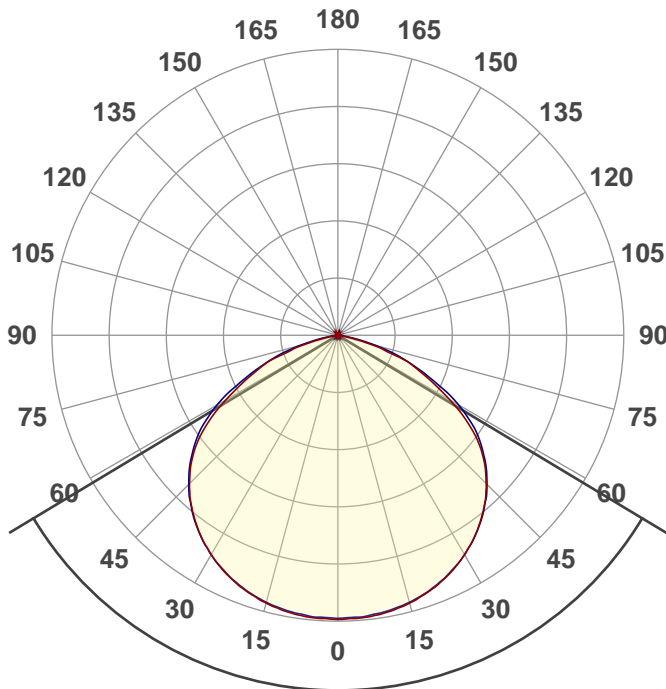

Beam angle **118°**



CIE 1931
x: 0,345
y: 0,361

THD Values:

Voltage: 2,8%

Current: 40,64%

Spectra

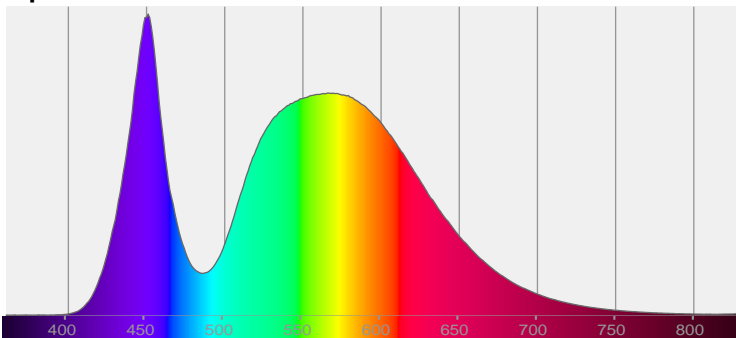

Power



Voltage: 113 V
Current: 0,260 A
Frequency: 60 Hz

ISO Diagrams

ISO lux diagram

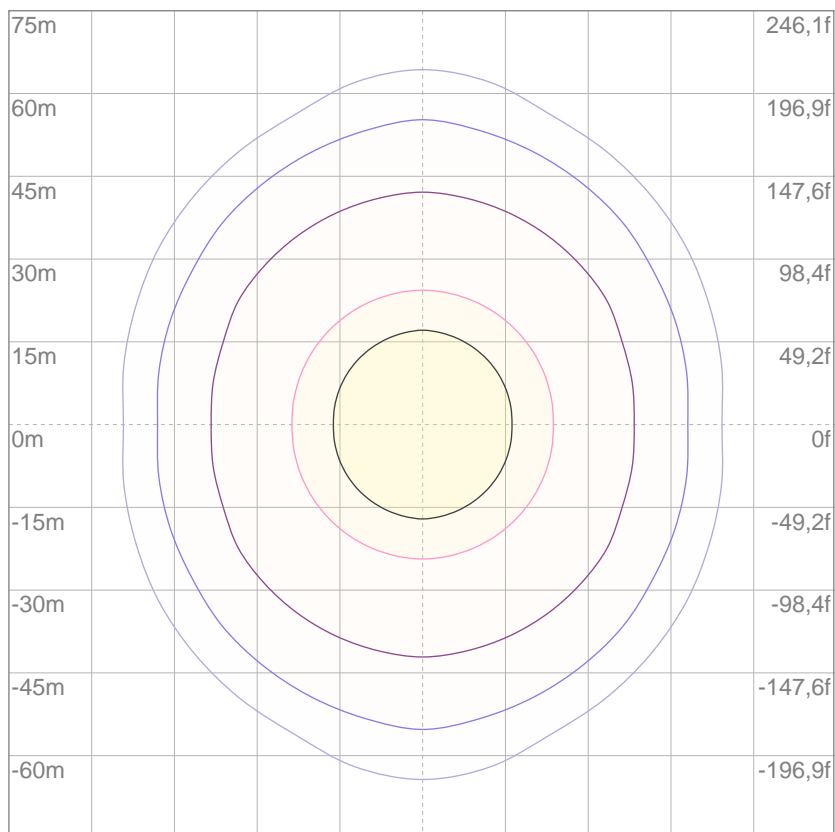

3%	0,267 lx
5%	0,446 lx
10%	0,892 lx
30%	2,67 lx
50%	4,46 lx

Conditions:
 Number of c-planes: 4
 Lux at center: 8,92 lx

Lux distribution on a surface when lamp is mounted at 10 meters from the surface.

Mounting height: 10 meters (33 f)

Color details

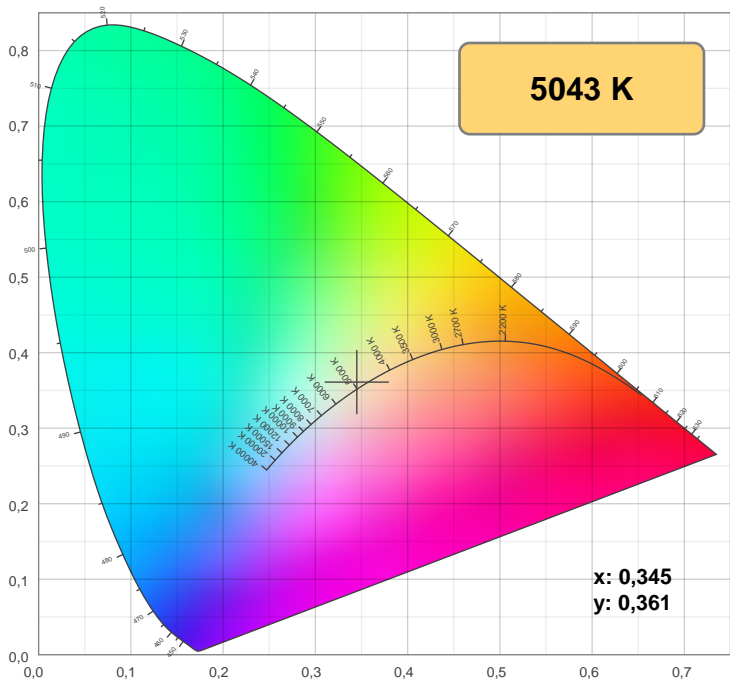

CIE 1931

CRI: 71,2 (R1-R8)

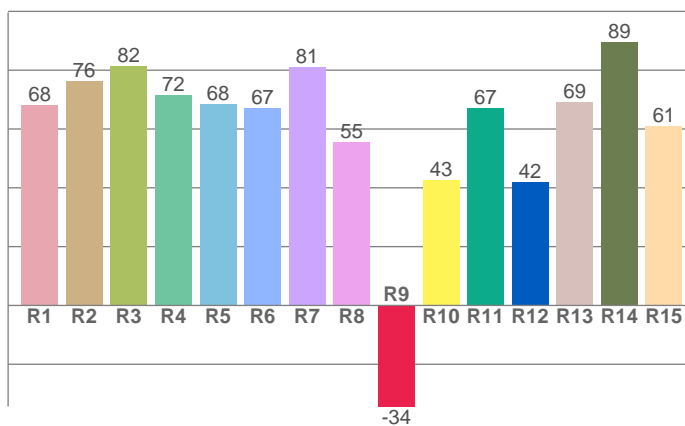

CRI R values, only R1-R8 are used to calculate final CRI value

R1	R2	R3	R4	R5	R6	R7	R8	R9	R10	R11	R12	R13	R14	R15
68,0	76,2	81,5	71,5	68,5	67,1	81,0	55,4	-34,4	42,7	67,3	41,8	69,2	89,4	61,1

Color parameters

Color temperature	Color rendering index	Red component	Color fidelity	Color gamut	Color quality scale	Color coordinate cie 1931	Color coordinate cie 1931	Color coordinate	Color coordinate	Color deviation from black body
CCT	CRI	CRI R9	TM30 Rf	TM30 Rg	CQS	x	y	u	v	Δuv
5043 K	71,2	-34,4	73,4	93,8	70,0	0,345	0,361	0,208	0,326	0,0016

TM-30 details

Rf 73,4
Fidelity index Rf

Rg 93,8
Gamut index Rg

Hue Bin	R _f	Shifts (%)	
		Chroma	Hue
1	69	-18%	-3%
2	75	-13%	9%
3	60	-6%	21%
4	71	4%	19%
5	80	10%	11%
6	86	9%	-3%
7	85	-2%	-10%
8	80	-10%	-8%
9	78	-17%	2%
10	62	-13%	19%
11	60	-3%	25%
12	76	6%	15%
13	83	13%	2%
14	77	9%	-9%
15	71	4%	-25%
16	73	-6%	-15%

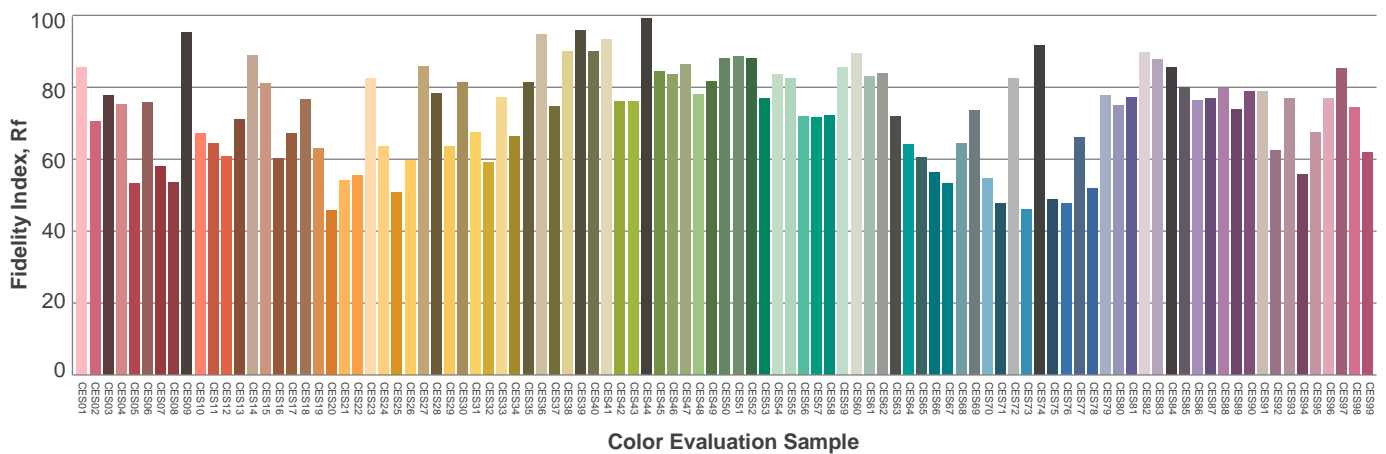
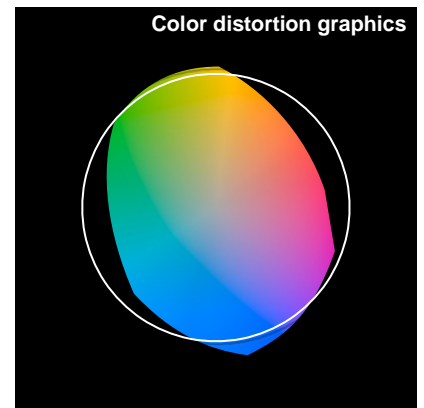
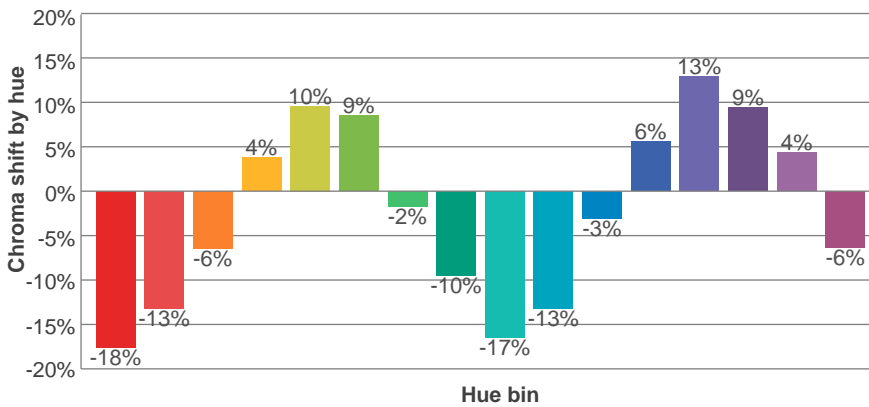
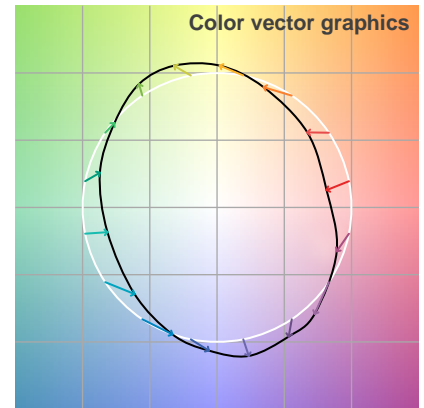
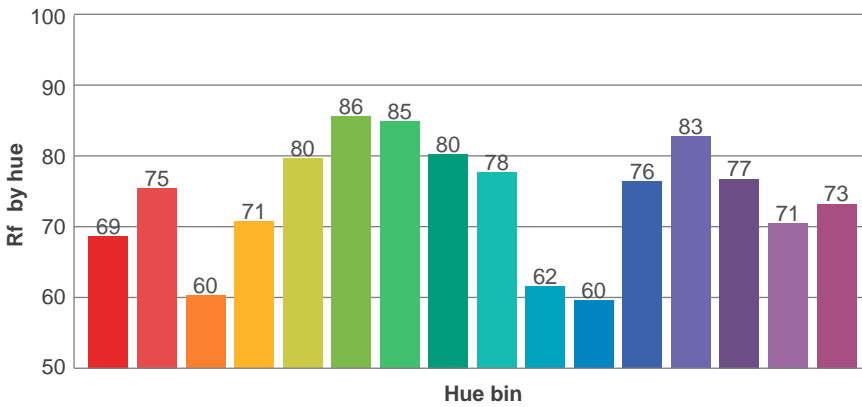
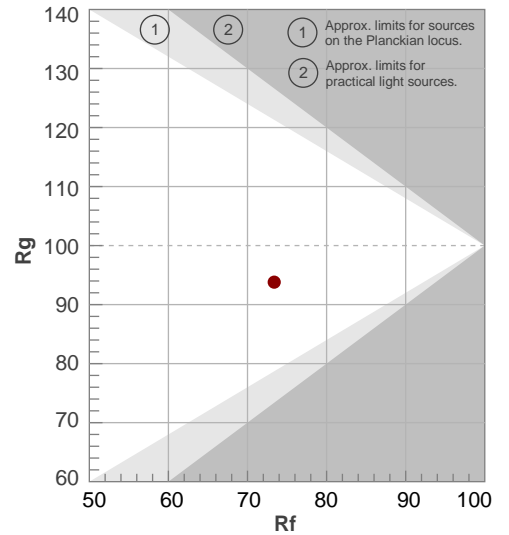

Beam details

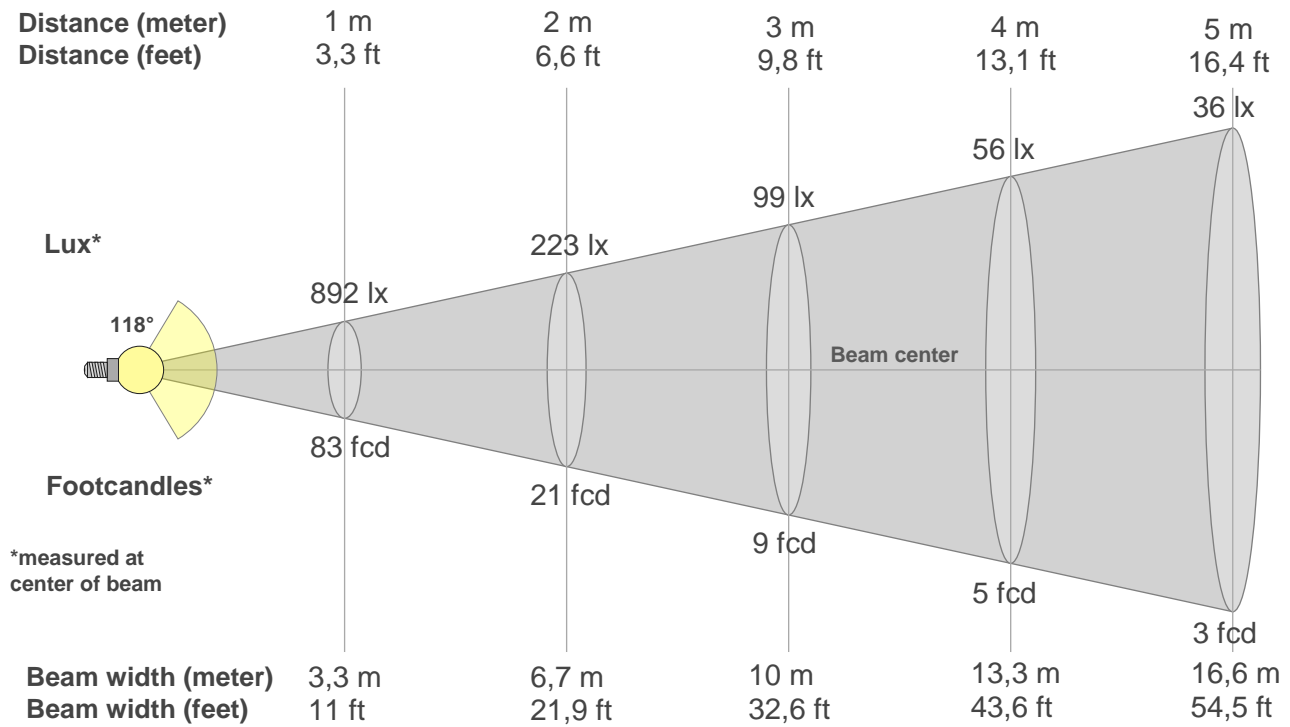

Beam intensities from 1-20m

1m	2m	3m	4m	5m	6m	7m	8m	9m	10m	11m	12m	13m	14m	15m	16m	17m	18m	19m	20m
3,3ft	6,6ft	9,8ft	13,1ft	16,4ft	19,7ft	23ft	26,2ft	29,5ft	32,8ft	36,1ft	39,4ft	42,7ft	45,9ft	49,2ft	52,5ft	55,8ft	59,1ft	62,3ft	65,6ft
892lx	223lx	99lx	56lx	36lx	25lx	18lx	14lx	11lx	9lx	7lx	6lx	5lx	5lx	4lx	3lx	3lx	3lx	2lx	2lx
82,8fcd	20,7fcd	9,2fcd	5,2fcd	3,3fcd	2,3fcd	1,7fcd	1,3fcd	1fcd	0,8fcd	0,7fcd	0,6fcd	0,5fcd	0,4fcd	0,4fcd	0,3fcd	0,3fcd	0,3fcd	0,2fcd	0,2fcd

Intensities in 0° c-plane

0°	5°	10°	15°	20°	25°	30°	35°	40°	45°	50°	55°	60°	65°	70°	75°	80°	85°	90°	95°
892	892	885	872	853	828	797	758	713	660	596	513	407	304	212	98	21	2	0	0
100%	100%	99%	98%	96%	93%	89%	85%	80%	74%	67%	58%	46%	34%	24%	11%	2%	0%	0%	0%

Intensities in 90° c-plane

0°	5°	10°	15°	20°	25°	30°	35°	40°	45°	50°	55°	60°	65°	70°	75°	80°	85°	90°	95°
892	889	881	869	851	826	796	759	715	663	602	532	439	324	222	122	41	4	0	0
100%	100%	99%	97%	95%	93%	89%	85%	80%	74%	68%	60%	49%	36%	25%	14%	5%	0%	0%	0%

Intensities in 180° c-plane

0°	5°	10°	15°	20°	25°	30°	35°	40°	45°	50°	55°	60°	65°	70°	75°	80°	85°	90°	95°
892	892	885	872	853	828	797	758	713	660	596	513	407	304	212	98	21	2	0	0
100%	100%	99%	98%	96%	93%	89%	85%	80%	74%	67%	58%	46%	34%	24%	11%	2%	0%	0%	0%

Intensities in 270° c-plane

0°	5°	10°	15°	20°	25°	30°	35°	40°	45°	50°	55°	60°	65°	70°	75°	80°	85°	90°	95°
892	889	881	869	851	826	796	759	715	663	602	532	439	324	222	122	41	4	0	0
100%	100%	99%	97%	95%	93%	89%	85%	80%	74%	68%	60%	49%	36%	25%	14%	5%	0%	0%	0%

Beam angle 50%	Field angle 10%	Cutoff angle 2,5%	Intensity ratio in 120° cone	Intensity ratio in 90° cone
118°	152,1°	161,7°	83,0%	55,4%

UGR

Glare Evaluation According to UGR

p Ceiling	70	70	50	50	30	70	70	50	50	30	
p Walls	50	30	50	30	30	50	30	50	30	30	
p Floor	20	20	20	20	20	20	20	20	20	20	
Room size X Y	Viewing direction at right angles to lamp axis					Viewing direction parallel to lamp axis					
2H	2H	26,6	27,8	26,9	28,1	28,3	26,8	28,0	27,0	28,3	28,5
	3H	27,7	28,9	28,1	29,2	29,4	27,9	29,1	28,3	29,4	29,6
	4H	27,9	29,1	28,3	29,4	29,6	28,2	29,4	28,6	29,6	29,9
	6H	28,0	29,0	28,3	29,3	29,7	28,3	29,4	28,7	29,6	30,0
	8H	27,9	28,9	28,3	29,2	29,7	28,3	29,3	28,6	29,6	30,0
4H	12H	27,9	28,8	28,3	29,2	29,6	28,3	29,2	28,6	29,5	30,0
	2H	27,1	28,3	27,6	28,6	28,8	27,3	28,5	27,7	28,7	29,0
	3H	28,5	29,4	28,8	29,7	30,2	28,6	29,6	29,0	29,9	30,4
	4H	28,7	29,6	29,1	30,0	30,5	28,9	29,8	29,4	30,2	30,8
	6H	28,7	29,6	29,2	29,9	30,3	29,0	29,9	29,5	30,2	30,6
8H	8H	28,7	29,4	29,2	29,8	30,2	29,0	29,8	29,5	30,2	30,5
	12H	28,6	29,3	29,1	29,7	30,2	29,0	29,6	29,5	30,0	30,5
	4H	28,8	29,5	29,3	29,9	30,3	29,0	29,8	29,5	30,1	30,5
	6H	28,9	29,4	29,4	29,9	30,4	29,2	29,7	29,7	30,2	30,8
	8H	28,9	29,3	29,4	29,9	30,5	29,2	29,7	29,7	30,2	30,8
12H	12H	28,8	29,2	29,4	29,7	30,3	29,2	29,6	29,7	30,1	30,7
	4H	28,7	29,4	29,2	29,8	30,3	29,0	29,6	29,5	30,0	30,5
	6H	28,9	29,3	29,4	29,9	30,5	29,2	29,7	29,7	30,2	30,8
	8H	28,8	29,2	29,4	29,7	30,4	29,2	29,6	29,7	30,1	30,7
	Variation of the observer position for the luminaire distance S										
S = 1.0H	0,1 / -0,1					0,1 / -0,2					
S = 1.5H	0,4 / -0,6					0,4 / -0,4					
S = 2.0H	1,0 / -1,2					1,0 / -1,2					
Standard table	n/a					n/a					
Correction summand	n/a					n/a					
Corrected glare indices referring to 2604 lm total luminous flux											

Light planning

Coefficients of Utilization

Ceiling reflectance	80				70				50			30			10			0			
Wall reflectance	70	50	30	10	70	50	30	10	50	30	10	50	30	10	50	30	10	0			
Floor reflectance	20	20	20	20	20	20	20	20	20	20	20	20	20	20	20	20	20	20	20	20	0
RCR	(RCR: Room Cavity Ratio)																				
	Room Values are expressed as percentage of Lumens delivered to the task surface																				
0	119	119	119	119	116	116	116	116	111	111	111	106	106	106	102	102	102	100			
1	110	105	101	98	107	103	99	96	99	96	93	95	93	90	91	89	88	86			
2	100	92	86	80	97	90	84	79	87	82	77	83	79	76	80	77	74	72			
3	91	81	73	67	89	79	72	66	76	70	65	74	68	64	71	67	63	61			
4	83	72	63	57	81	70	62	56	68	61	55	66	59	55	63	58	54	52			
5	77	64	55	49	75	63	54	48	61	53	48	59	52	47	57	51	47	45			
6	71	57	49	42	69	57	48	42	55	47	42	53	46	41	51	46	41	39			
7	65	52	43	37	64	51	43	37	50	42	37	48	41	36	47	41	36	34			
8	61	47	39	33	59	47	39	33	45	38	33	44	37	33	43	37	32	30			
9	57	43	35	30	55	43	35	30	42	34	29	41	34	29	40	33	29	27			
10	53	40	32	27	52	39	32	27	38	31	27	37	31	26	37	31	26	25			

LAMPS (number of lamps)

Luminaire budgetary diagram

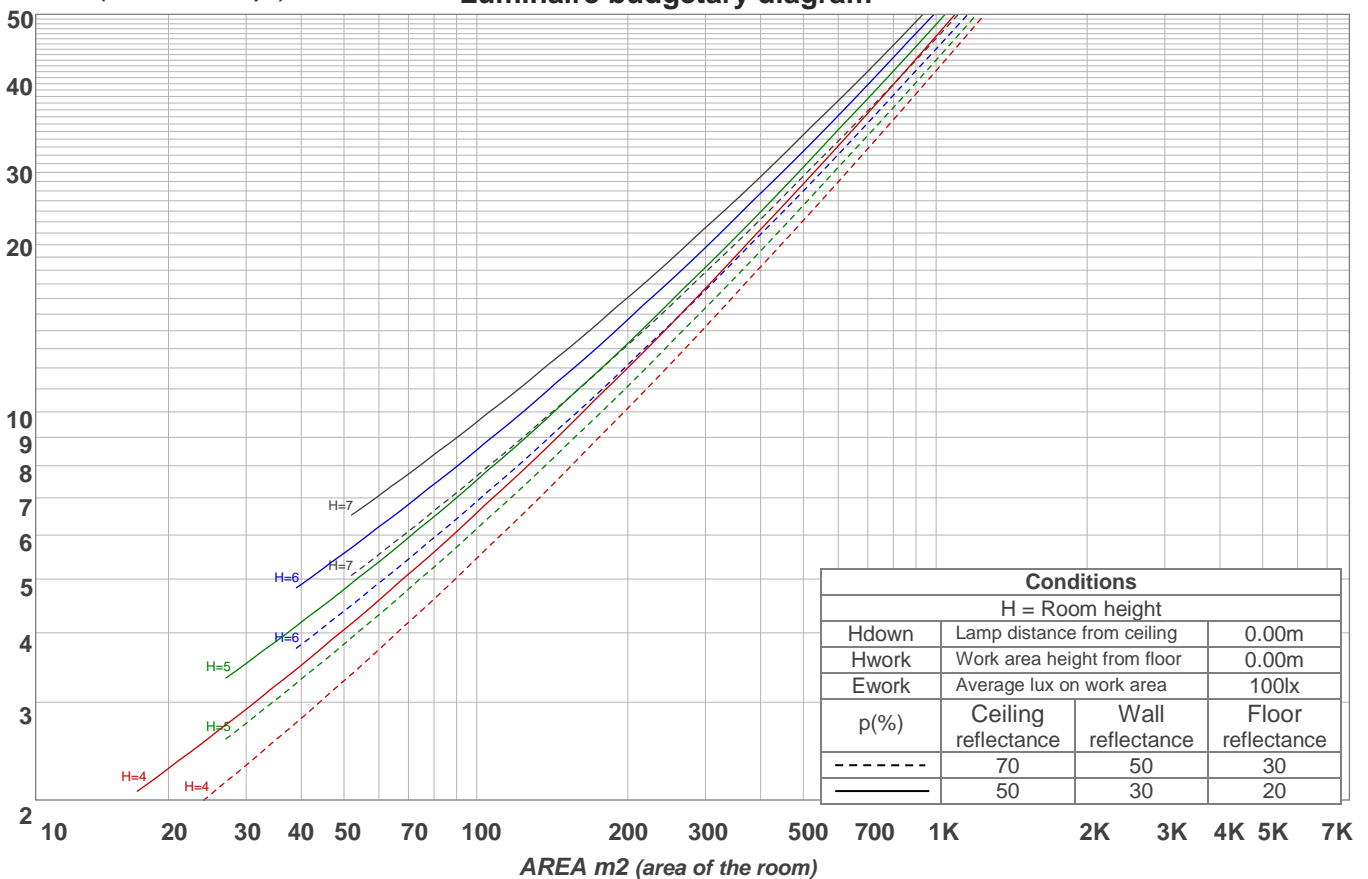

Zonal Lumen Summary

0°-10°	10°-20°	20°-30°	30°-40°	40°-50°	50°-60°	60°-70°	70°-80°	80°-90°
84,7 lm	246 lm	382 lm	475 lm	510 lm	464 lm	314 lm	121 lm	7,77 lm
90°-100°	100°-110°	110°-120°	120°-130°	130°-140°	140°-150°	150°-160°	160°-170°	170°-180°
0,103 lm	0,092 lm	0,107 lm	0,115 lm	0,107 lm	0,087 lm	0,061 lm	0,035 lm	0,009 lm

Road report

LCS table

BUG rating:	B1 U1 G0	
Forward light	Lumens	Lumens %
Low(0-30):	356,2	13,7%
Medium(30-60):	723,9	27,8%
High(60-80):	217,3	8,3%
Very high(80-90):	4	0,2%
Back light		
Low(0-30):	356,2	13,7%
Medium(30-60):	723,9	27,8%
High(60-80):	217,3	8,3%
Very high(80-90):	4	0,2%
Uplight		
Low(90-100):	0,1	0%
High(100-180):	0,6	0%

LCS graph

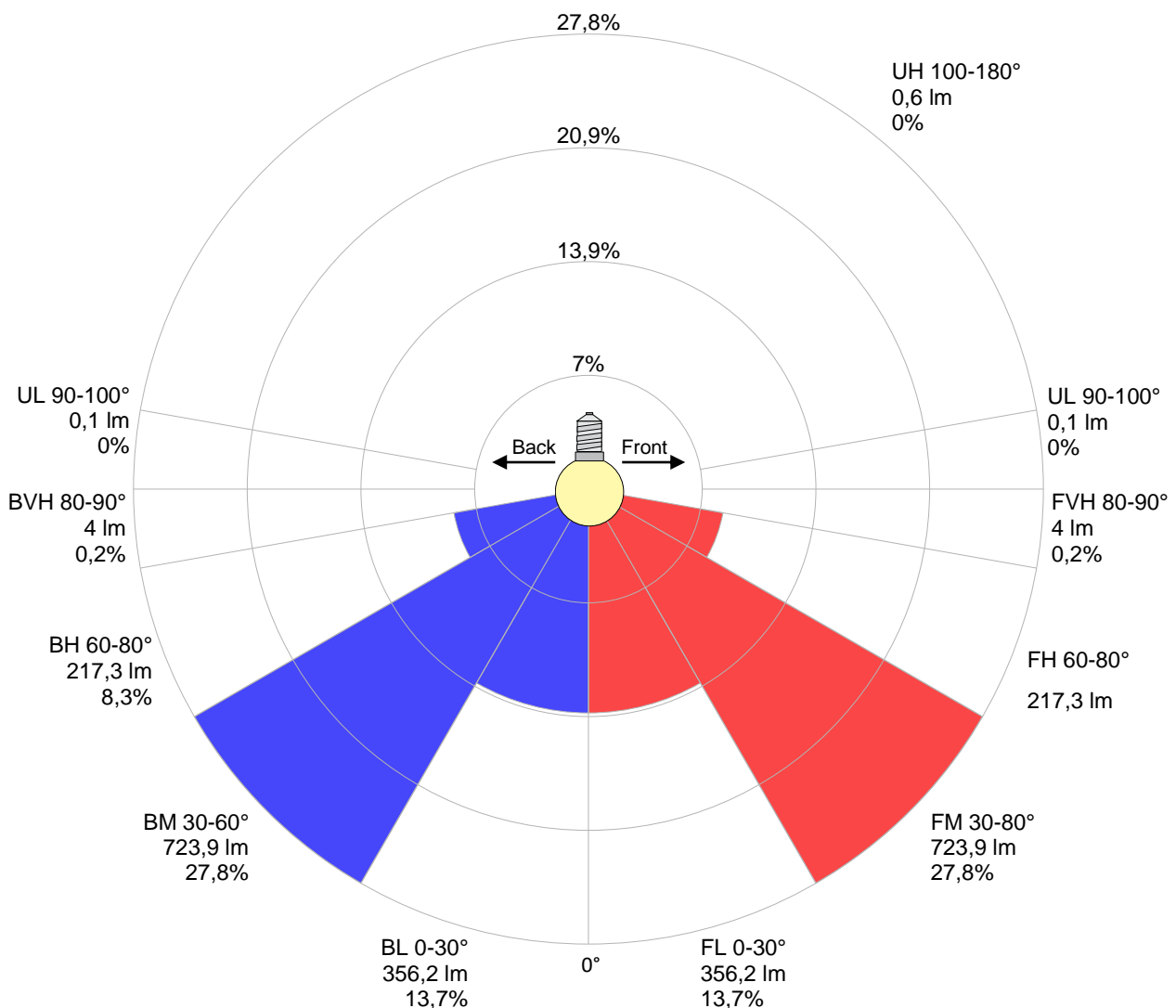

Stabilization

Warmup curve

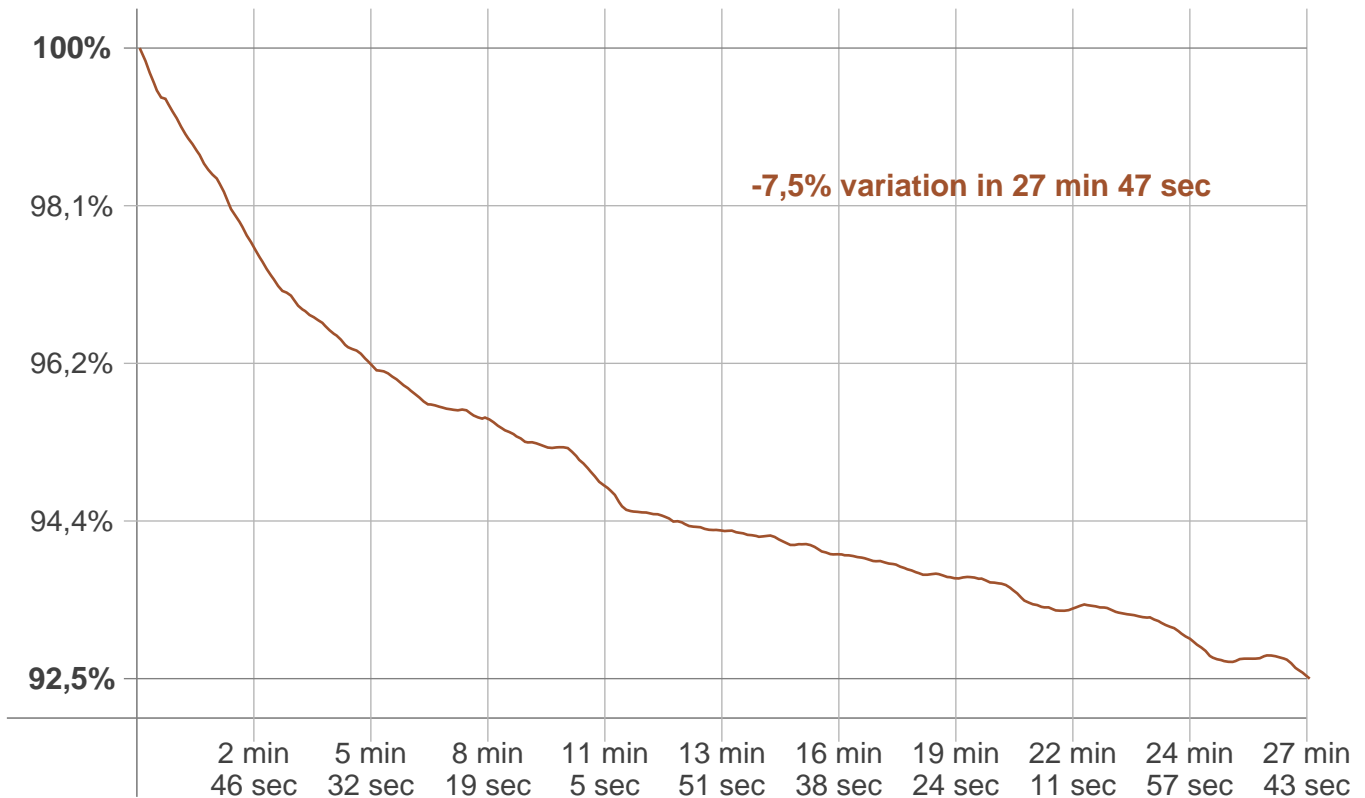

Warmup result

Warmup time:	27 min 47 sec
Warmup variation	-7,6%

Warmup conditions

Stable period:	15 min
Stable change max:	2,0%
Minimum time:	15 min

Color temperature change

CCT start	CCT change	CCT end
4992 K	+51 K	5043 K

Output change

Output start	Output change	Output end
2804 lm	-200 lm	2604 lm