

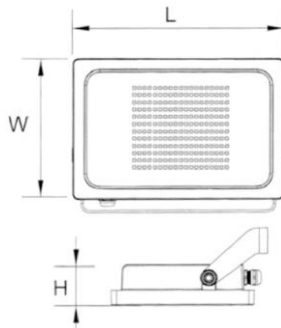

**Dimensiones (mm)**

**Largo (L): 180; Ancho (W): 140**  
**Alto (H): 30.**



**Código**

**ERIS-50W-3K**

**Descripción**

Luminaria tipo reflector diseñada con módulo de LED (DOB). Para anclar en piso, poste o muro por medio del sujetador ubicado en la parte trasera. Compuesta en la parte interna por una pantalla blanca y un difusor en vidrio templado.



**Materiales y acabado**

Cuerpo en termoplástico (PA) inyectado. Sujetador fabricado en lámina de hierro, con acabado en pintura poliéster electrostática en polvo.

**Color**

Negra.

**Características técnicas**

<b>LED</b>	 117°	 30,000h	<b>IP</b> 65	<b>IK</b> 06
<b>PF</b> 0,92	<b>THD</b> <50%	<b>Hz</b> 50/60	<b>V</b> 100-265	

**Fuente de luz**

Módulo de LED.

Potencia Nominal	CRI	K	Lm / W	Lm de Salida
50W	>70	3000	75	3447

**Características de fuente de luz**

- Color temperatura disponible 3000K (cálido).
- “DOB”, Driver on board.
- Potencia de Salida: 45,7W.

## Instalación

Se debe tener en cuenta la alimentación de la luminaria, para ubicarla.

1. Instale los soportes.
2. Afloje los pernos a ambos lados del soporte.
3. Ajuste el ángulo del reflector.
4. Apriete los pernos a ambos lados del soporte.
5. Conecte el cableado del reflector.  
Encienda la alimentación para asegurarse de que el reflector funcione.

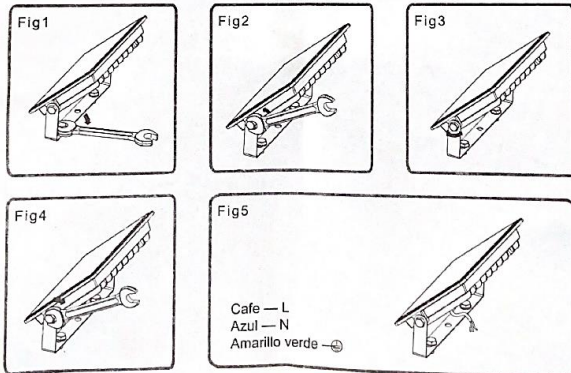

**Nota:** Distecsa garantiza el buen y correcto funcionamiento del sistema eléctrico antes de ser instalado, algún retroceso o falla en el sistema corre por parte del personal de instalación.

## Mantenimiento de las luminarias

Es esencial llevar a cabo periódicamente inspecciones y mantenimiento a las luminarias instaladas, ya que estas reciben influencia de las condiciones de operación y del medio donde se ubican.

### 1. Mantenimiento correctivo

El mantenimiento correctivo de las luminarias consiste en localizar, reparar y adecuar las instalaciones para que funcionen el máximo número de horas posible, con el desempeño para el que fueron diseñadas.

Las actividades que componen el mantenimiento correctivo son:

- Localización y reparación de averías
- Adecuación de instalaciones

Para la ejecución del mantenimiento correctivo es importante tener en cuenta los siguientes aspectos:

- Si se genera algún inconveniente en la regleta LED por favor comunicarse con la empresa.
- Revisar el encendido, apagado y el correcto funcionamiento de la luminaria.
- Limpiar las regletas LED y el conjunto óptico de las luminarias con aire comprimido. Para manipular la luminaria se recomienda utilizar guantes quirúrgicos.

### 2. Mantenimiento preventivo

Dentro de las técnicas de diagnóstico se deben considerar las mediciones eléctricas en diferentes puntos de la red, así como la medición de parámetros eléctricos de operación de las luminarias y sus componentes.

### 3. Mantenimiento de las instalaciones eléctricas de las luminarias

La persona encargada de la operación y el mantenimiento de las instalaciones eléctricas de las luminarias será responsable de mantenerlas en condiciones seguras, por lo tanto deben garantizar que se cumplan las disposiciones del reglamento que establece los requisitos que deben cumplir los sistemas de alumbrado y verificar que estas conexiones no presenten ningún riesgo para la salud o la vida de las personas, animales o el medio ambiente.

Light efficiency:



Light quality:



Color temperature:



Output: 3447 lm

Peak: 1205 cd

Power: 45,7 W

PF: 0,92



Product name:  
E0554-ERIS-50W-3K

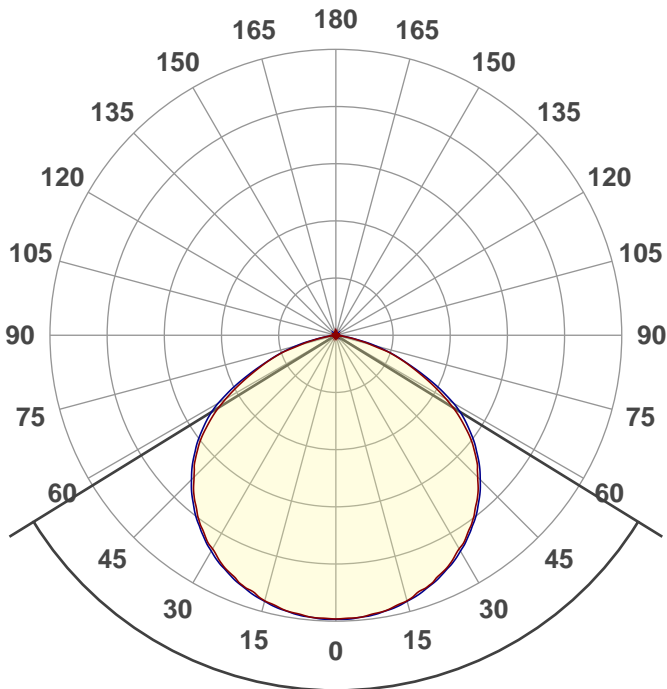

Beam angle **116,6°**



CIE 1931  
x: 0,436  
y: 0,402

THD Values:

Voltage: 2,93%

Current: 40,13%

Spectra

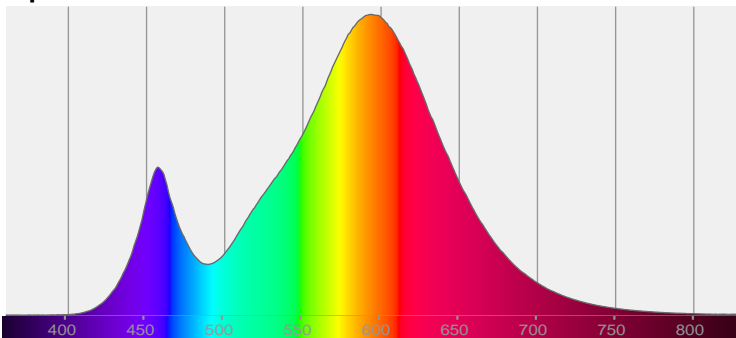

Power

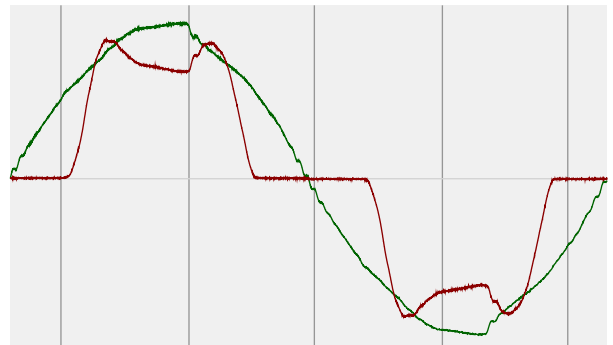

Voltage: 112 V  
Current: 0,442 A  
Frequency: 60 Hz

# ISO Diagrams

## ISO lux diagram

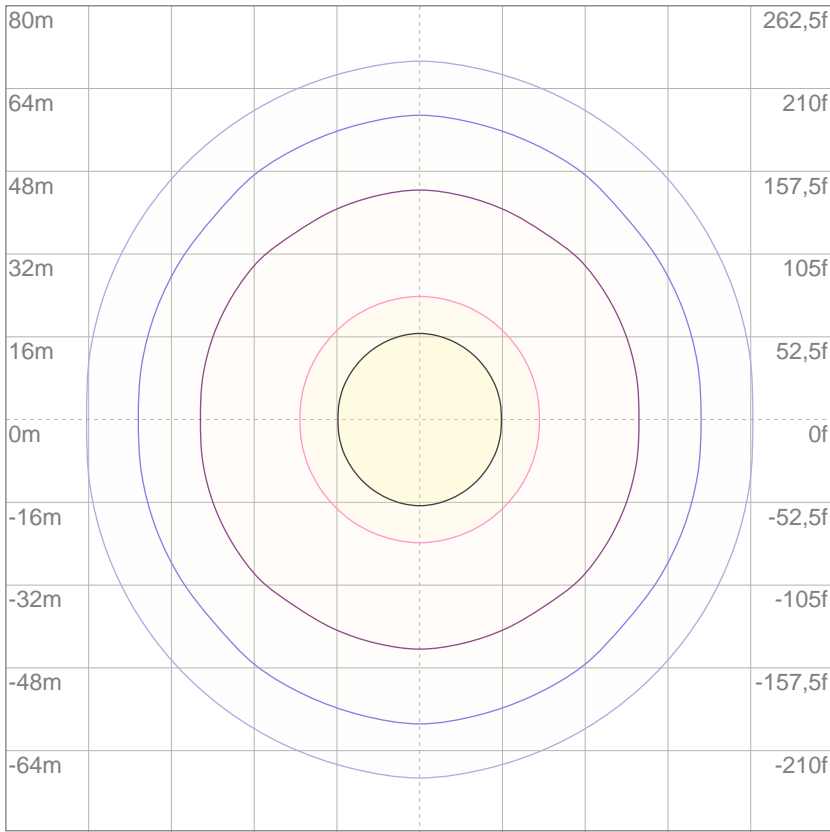

3%	0,361 lx
5%	0,602 lx
10%	1,20 lx
30%	3,61 lx
50%	6,02 lx

**Conditions:**  
 Number of c-planes: 4  
 Lux at center: 12,0 lx

*Lux distribution on a surface when lamp is mounted at 10 meters from the surface.*

Mounting height: 10 meters (33 f)

## Color details

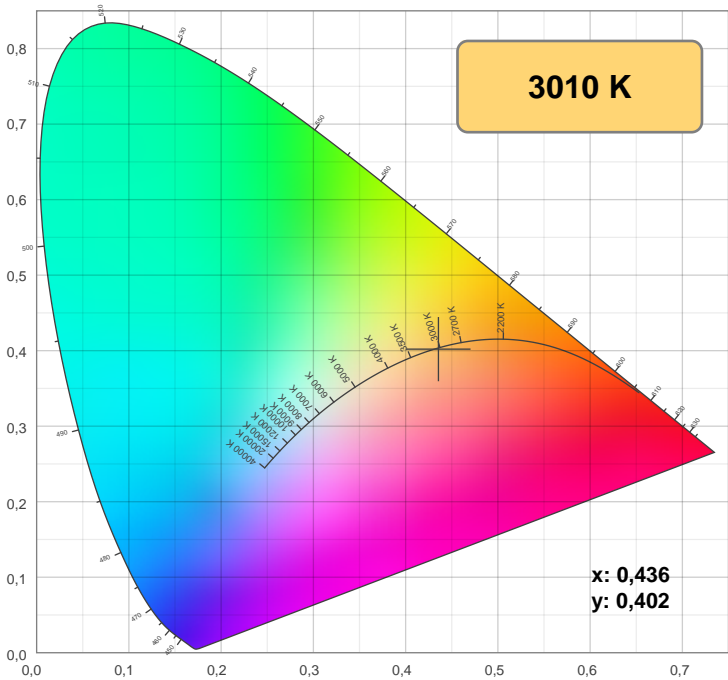

CIE 1931

## CRI: 72,1 (R1-R8)

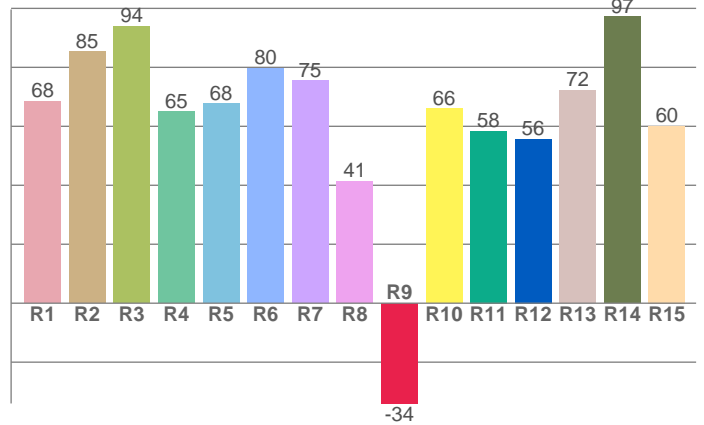

CRI R values, only R1-R8 are used to calculate final CRI value

R1	R2	R3	R4	R5	R6	R7	R8	R9	R10	R11	R12	R13	R14	R15
68,4	85,3	93,9	65,0	67,7	79,6	75,5	41,3	-34,0	66,0	58,5	55,7	72,1	97,2	60,0

## Color parameters

Color temperature	Color rendering index	Red component	Color fidelity	Color gamut	Color quality scale	Color coordinate cie 1931	Color coordinate cie 1931	Color coordinate	Color coordinate	Color deviation from black body
CCT	CRI	CRI R9	TM30 Rf	TM30 Rg	CQS	x	y	u	v	$\Delta uv$
3010 K	72,1	-34,0	76,5	90,7	71,7	0,436	0,402	0,251	0,347	-0,0006

TM-30 details

**Rf 76,5**  
Fidelity index Rf

**Rg 90,7**  
Gamut index Rg

Hue Bin	R <sub>f</sub>	Shifts (%)	
		Chroma	Hue
1	69	-17%	1%
2	70	-13%	11%
3	66	-5%	17%
4	83	1%	11%
5	90	2%	5%
6	90	1%	-6%
7	80	-8%	-10%
8	82	-11%	-1%
9	78	-12%	8%
10	68	-8%	19%
11	70	-1%	22%
12	80	8%	8%
13	86	6%	-7%
14	75	7%	-19%
15	71	-4%	-18%
16	70	-13%	-19%

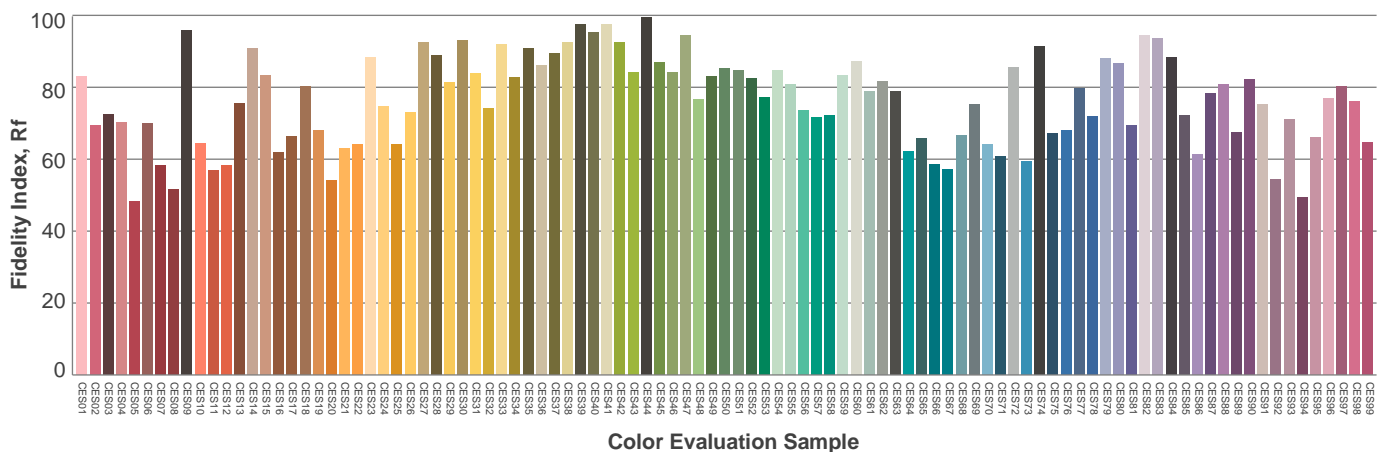
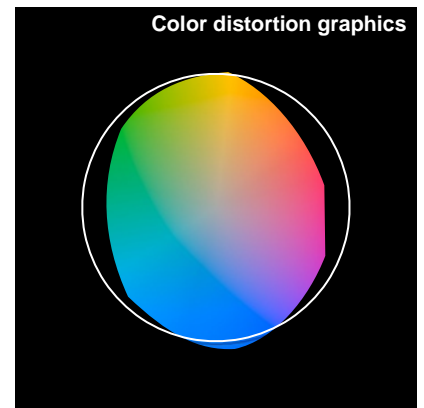
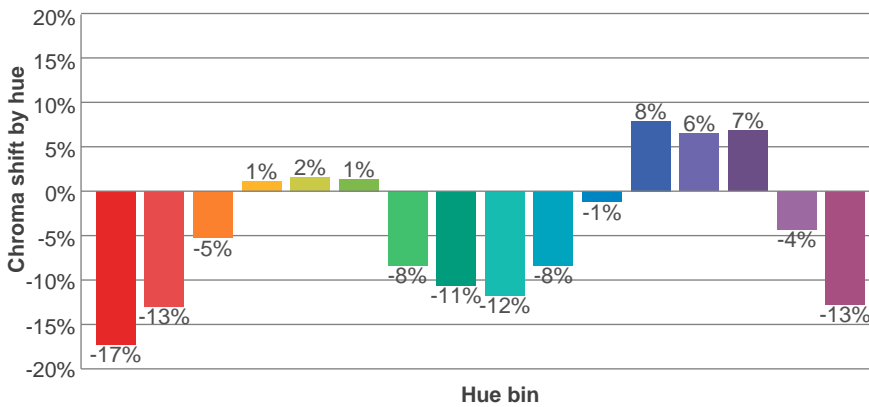
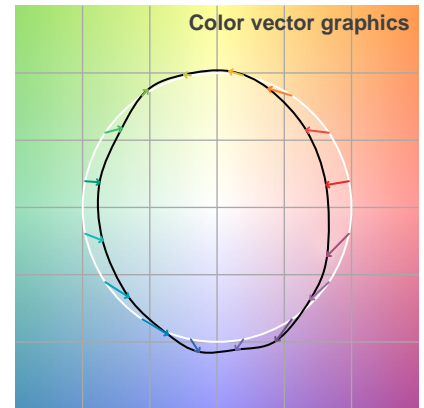
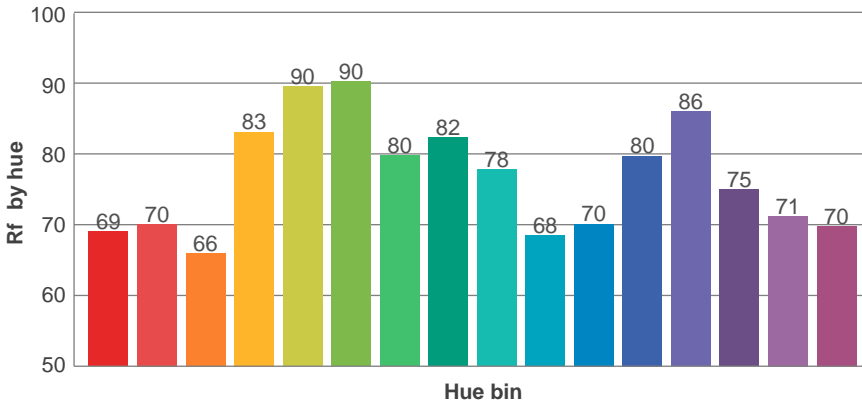
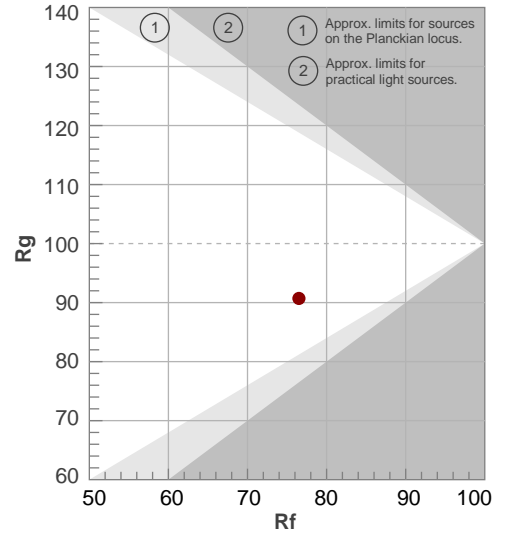

## Beam details

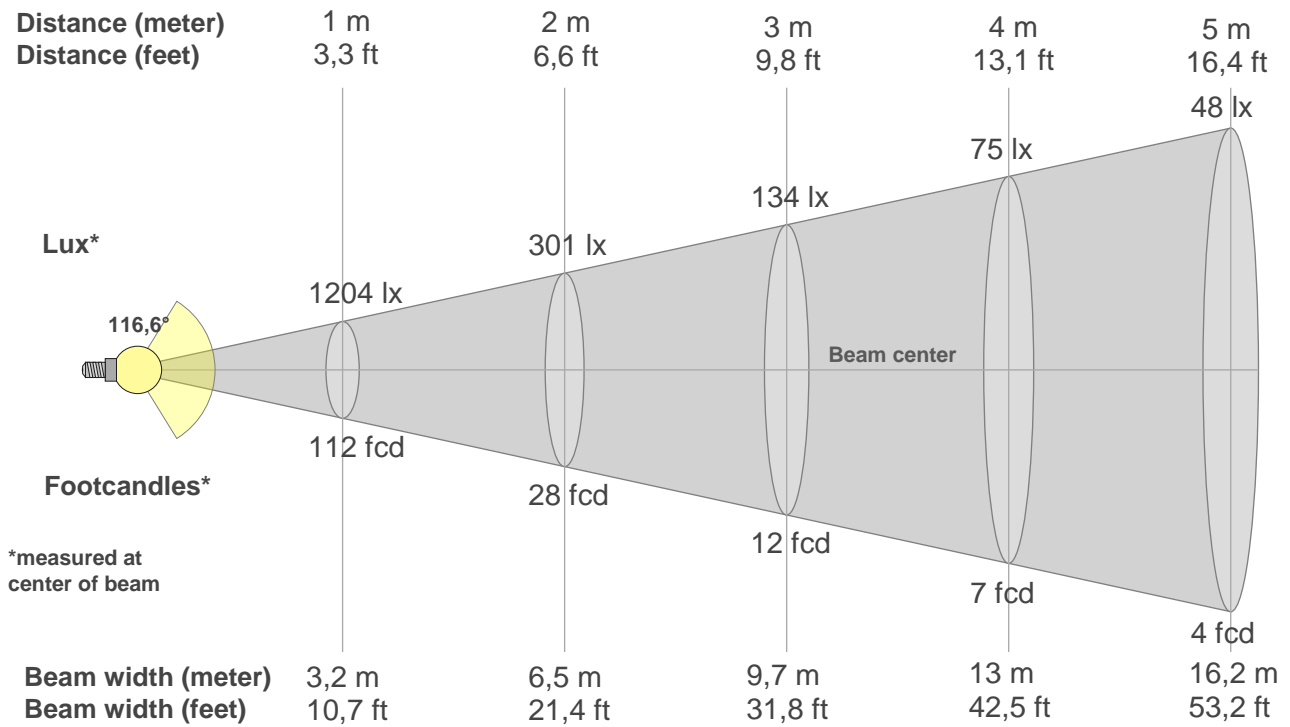

### Beam intensities from 1-20m

1m	2m	3m	4m	5m	6m	7m	8m	9m	10m	11m	12m	13m	14m	15m	16m	17m	18m	19m	20m
3,3ft	6,6ft	9,8ft	13,1ft	16,4ft	19,7ft	23ft	26,2ft	29,5ft	32,8ft	36,1ft	39,4ft	42,7ft	45,9ft	49,2ft	52,5ft	55,8ft	59,1ft	62,3ft	65,6ft
1204lx	301lx	134lx	75lx	48lx	33lx	25lx	19lx	15lx	12lx	10lx	8lx	7lx	6lx	5lx	5lx	4lx	4lx	3lx	3lx
111,8fcd	28fcd	12,4fcd	7fcd	4,5fcd	3,1fcd	2,3fcd	1,7fcd	1,4fcd	1,1fcd	0,9fcd	0,8fcd	0,7fcd	0,6fcd	0,5fcd	0,4fcd	0,4fcd	0,3fcd	0,3fcd	0,3fcd

### Intensities in 0° c-plane

0°	5°	10°	15°	20°	25°	30°	35°	40°	45°	50°	55°	60°	65°	70°	75°	80°	85°	90°	95°
1204	1200	1188	1166	1135	1097	1046	994	928	851	768	664	539	403	285	152	54	4	0	0
100%	100%	99%	97%	94%	91%	87%	83%	77%	71%	64%	55%	45%	34%	24%	13%	4%	0%	0%	0%

### Intensities in 90° c-plane

0°	5°	10°	15°	20°	25°	30°	35°	40°	45°	50°	55°	60°	65°	70°	75°	80°	85°	90°	95°
1204	1200	1189	1168	1139	1102	1057	1002	939	866	783	688	576	426	290	175	66	7	0	0
100%	100%	99%	97%	95%	92%	88%	83%	78%	72%	65%	57%	48%	35%	24%	15%	5%	1%	0%	0%

### Intensities in 180° c-plane

0°	5°	10°	15°	20°	25°	30°	35°	40°	45°	50°	55°	60°	65°	70°	75°	80°	85°	90°	95°
1204	1200	1188	1166	1135	1097	1046	994	928	851	768	664	539	403	285	152	54	4	0	0
100%	100%	99%	97%	94%	91%	87%	83%	77%	71%	64%	55%	45%	34%	24%	13%	4%	0%	0%	0%

### Intensities in 270° c-plane

0°	5°	10°	15°	20°	25°	30°	35°	40°	45°	50°	55°	60°	65°	70°	75°	80°	85°	90°	95°
1204	1200	1189	1168	1139	1102	1057	1002	939	866	783	688	576	426	290	175	66	7	0	0
100%	100%	99%	97%	95%	92%	88%	83%	78%	72%	65%	57%	48%	35%	24%	15%	5%	1%	0%	0%

Beam angle 50%	Field angle 10%	Cutoff angle 2,5%	Intensity ratio in 120° cone	Intensity ratio in 90° cone
116,6°	153,9°	164°	82,4%	55,3%

## UGR

### Glare Evaluation According to UGR

p Ceiling	70	70	50	50	30	70	70	50	50	30	
p Walls	50	30	50	30	30	50	30	50	30	30	
p Floor	20	20	20	20	20	20	20	20	20	20	
Room size X Y	Viewing direction at right angles to lamp axis					Viewing direction parallel to lamp axis					
2H	2H	26,0	27,2	26,3	27,5	27,8	26,2	27,4	26,4	27,7	27,9
	3H	27,1	28,4	27,5	28,6	28,8	27,3	28,5	27,7	28,8	29,0
	4H	27,5	28,6	27,9	28,9	29,2	27,7	28,8	28,1	29,1	29,4
	6H	27,6	28,6	27,9	28,9	29,3	27,9	28,9	28,2	29,2	29,5
	8H	27,6	28,6	27,9	28,9	29,3	27,8	28,8	28,2	29,1	29,6
12H	27,5	28,5	27,9	28,8	29,3	27,8	28,7	28,2	29,1	29,5	
4H	2H	26,6	27,7	27,0	28,0	28,3	26,7	27,9	27,1	28,2	28,4
	3H	27,9	28,9	28,3	29,2	29,7	28,1	29,0	28,5	29,4	29,8
	4H	28,3	29,1	28,7	29,6	30,1	28,5	29,3	28,9	29,8	30,3
	6H	28,4	29,2	28,9	29,6	30,0	28,6	29,5	29,1	29,8	30,2
	8H	28,4	29,1	28,9	29,5	29,9	28,6	29,4	29,1	29,7	30,1
12H	28,3	29,0	28,8	29,4	29,9	28,6	29,2	29,1	29,6	30,1	
8H	4H	28,4	29,2	28,9	29,5	29,9	28,6	29,3	29,1	29,7	30,1
	6H	28,6	29,2	29,1	29,6	30,2	28,8	29,4	29,3	29,8	30,4
	8H	28,6	29,1	29,1	29,6	30,3	28,8	29,3	29,4	29,9	30,5
	12H	28,6	29,0	29,2	29,5	30,1	28,8	29,2	29,4	29,7	30,3
12H	4H	28,4	29,0	28,9	29,4	29,9	28,5	29,2	29,0	29,6	30,1
	6H	28,6	29,1	29,1	29,6	30,2	28,8	29,3	29,3	29,8	30,5
	8H	28,6	29,0	29,2	29,5	30,1	28,8	29,2	29,4	29,7	30,3
Variation of the observer position for the luminaire distance S											
S = 1.0H	0,1 / -0,2					0,1 / -0,2					
S = 1.5H	0,4 / -0,6					0,3 / -0,4					
S = 2.0H	0,9 / -1,1					0,9 / -1,2					
Standard table	n/a					n/a					
Correction summand	n/a					n/a					
Corrected glare indices referring to 3447 lm total luminous flux											

# Light planning

## Coefficients of Utilization

Ceiling reflectance	80				70				50			30			10			0			
Wall reflectance	70	50	30	10	70	50	30	10	50	30	10	50	30	10	50	30	10	0			
Floor reflectance	20	20	20	20	20	20	20	20	20	20	20	20	20	20	20	20	20	20	20	20	0
<b>RCR</b>	<b>(RCR: Room Cavity Ratio)</b>																				
	Room Values are expressed as percentage of Lumens delivered to the task surface																				
0	119	119	119	119	116	116	116	116	111	111	111	106	106	106	102	102	102	100			
1	110	105	101	98	107	103	99	96	99	96	93	95	92	90	91	89	87	85			
2	100	92	85	80	97	90	84	79	87	81	77	83	79	75	80	77	74	72			
3	91	81	73	67	89	79	72	66	76	70	65	74	68	64	71	66	63	60			
4	83	72	63	56	81	70	62	56	68	61	55	65	59	54	63	58	54	52			
5	77	64	55	48	74	63	54	48	61	53	48	59	52	47	57	51	47	44			
6	71	57	49	42	69	56	48	42	55	47	42	53	46	41	51	45	41	39			
7	65	52	43	37	64	51	43	37	50	42	37	48	41	36	47	41	36	34			
8	61	47	39	33	59	47	39	33	45	38	33	44	37	33	43	37	32	30			
9	57	43	35	30	55	43	35	30	42	34	29	41	34	29	40	34	29	27			
10	53	40	32	27	52	39	32	27	38	31	27	38	31	27	37	31	26	25			

LAMPS (number of lamps)

### Luminaire budgetary diagram

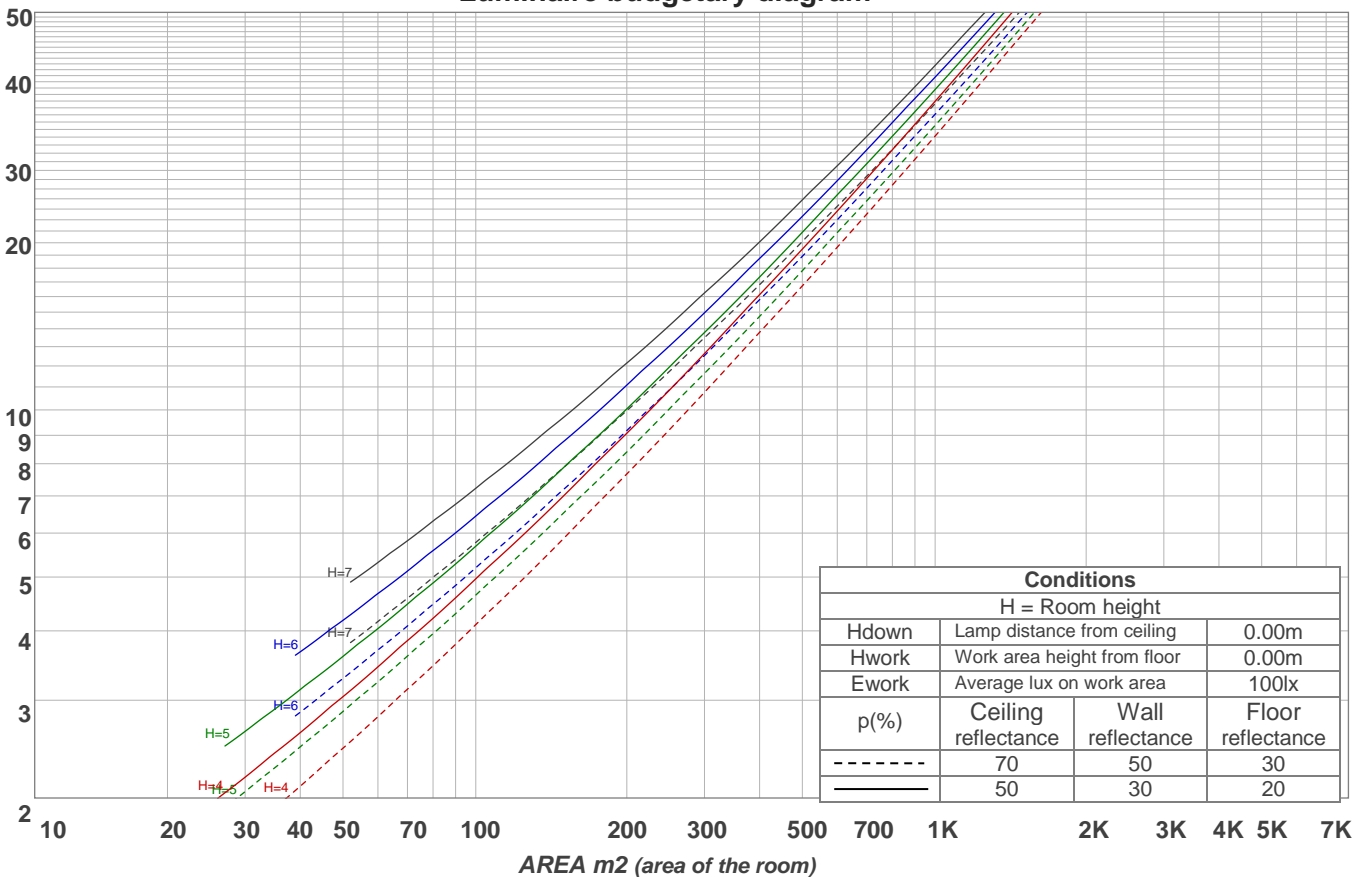

### Zonal Lumen Summary

0°-10°	10°-20°	20°-30°	30°-40°	40°-50°	50°-60°	60°-70°	70°-80°	80°-90°
114 lm	329 lm	507 lm	625 lm	663 lm	603 lm	413 lm	177 lm	15,3 lm
90°-100°	100°-110°	110°-120°	120°-130°	130°-140°	140°-150°	150°-160°	160°-170°	170°-180°
0,145 lm	0,159 lm	0,206 lm	0,225 lm	0,203 lm	0,167 lm	0,119 lm	0,070 lm	0,022 lm



# Road report

LCS table

BUG rating:	B1 U1 G0	
<b>Forward light</b>	Lumens	Lumens %
Low(0-30):	475,2	13,8%
Medium(30-60):	944,8	27,4%
High(60-80):	294,8	8,6%
Very high(80-90):	7,8	0,2%
<b>Back light</b>		
Low(0-30):	475,2	13,8%
Medium(30-60):	944,8	27,4%
High(60-80):	294,8	8,6%
Very high(80-90):	7,8	0,2%
<b>Uplight</b>		
Low(90-100):	0,1	0%
High(100-180):	1,2	0%

LCS graph

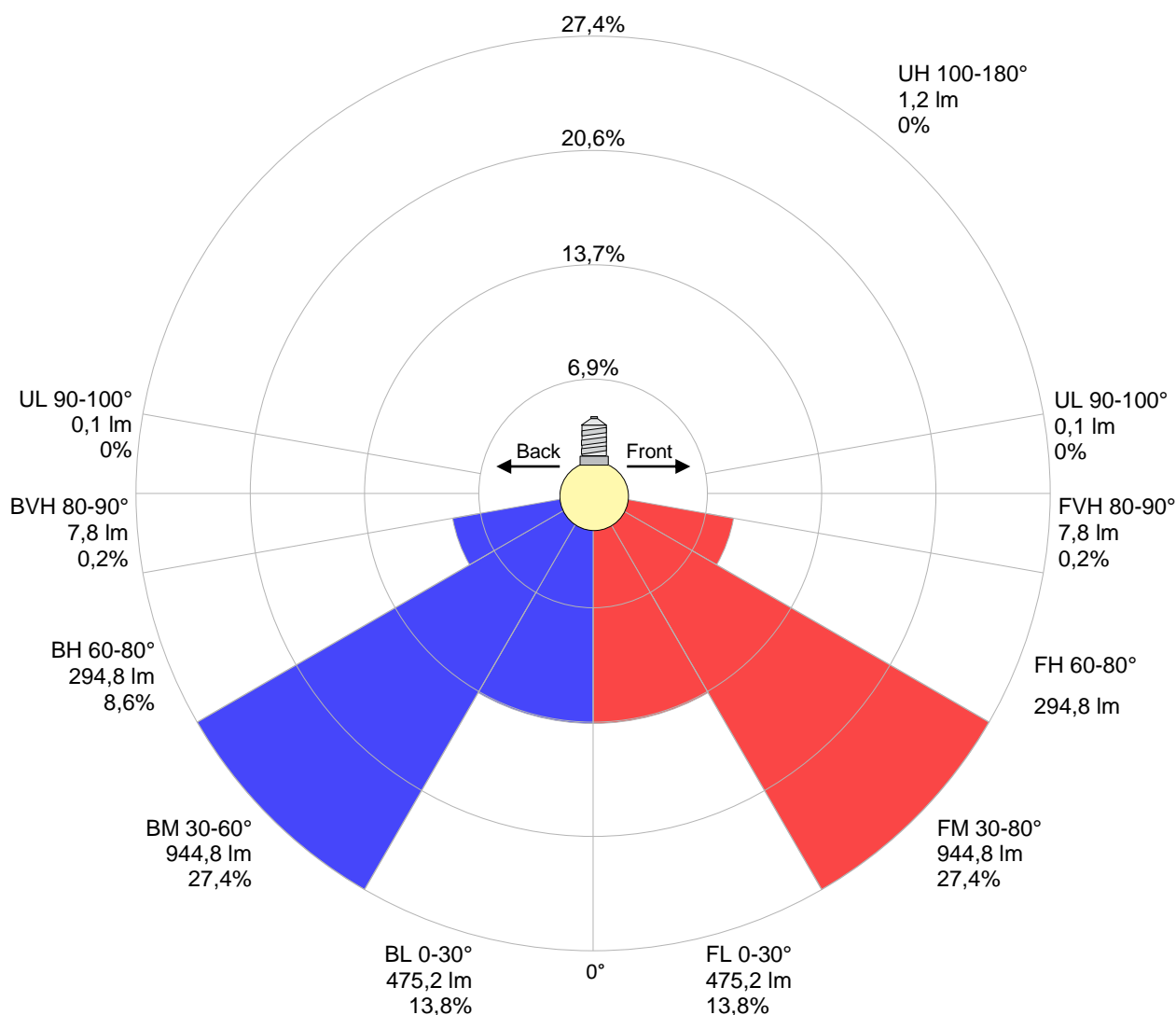

## Stabilization

### Warmup curve

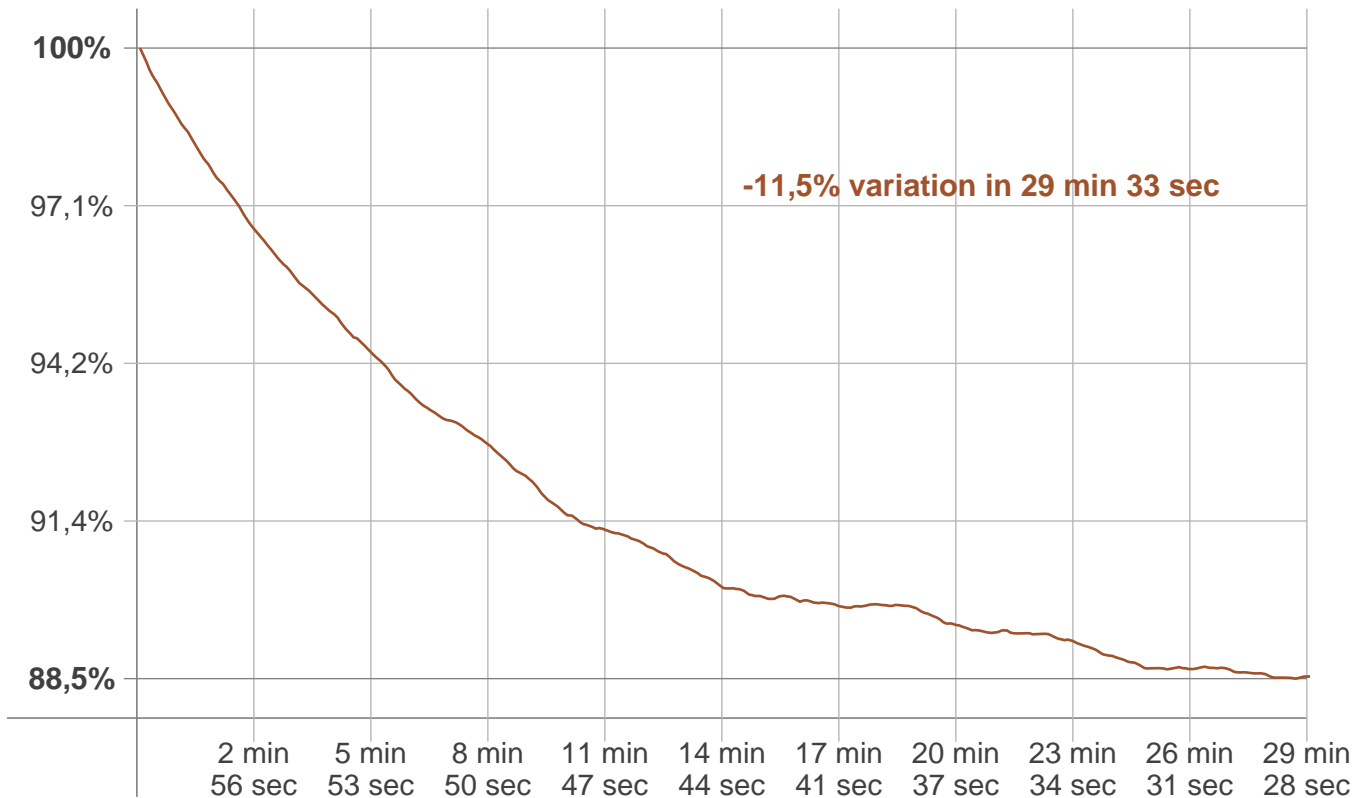

### Warmup result

Warmup time:	29 min 33 sec
Warmup variation	-11,7%

### Warmup conditions

Stable period:	15 min
Stable change max:	2,0%
Minimum time:	15 min

### Color temperature change

CCT start	CCT change	CCT end
2958 K	+52 K	3010 K

### Output change

Output start	Output change	Output end
3878 lm	-432 lm	3447 lm