

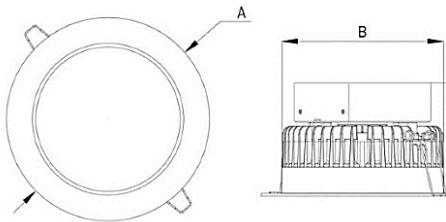

Dimensiones (mm)

A: Ø230
B: Ø205



Código

K201-L35-PRO-4K

Descripción

Luminaria tipo bala, diseñada con módulo de LED. Empotrada al techo por medio de sujetadores ubicados en los laterales. Compuesta con un disipador en aluminio y un difusor en acrílico opal.



Materiales y acabado

Sujetadores y resortes en hierro con acabado galvanizado. Cuerpo y aro en aluminio inyectado, con acabado en pintura poliéster electrostática en polvo a prueba de radiación UV.

Color

Blanco Brillante.

Características técnicas

LED	 102°	 40,000h	IP 20	IK 04
PF 0,96	THD <20%	°C 0-55	V 120-277	

Fuente de luz

Bala con módulo de LED.

Potencia Nominal	CRI	K	Lm / W	Lm de Salida
35W	>70	4000	135	3926

.....
Opción fuente regulable 1-10V o DALI.

Características de fuente de luz

- Color temperatura disponible 4000K (neutro).
- Potencia de Salida: 29,1W.

Instalación

Se debe tener en cuenta la alimentación de la luminaria, para ubicarla.

1. Realizar una perforación en el techo (drywall, madera), en donde desea ubicar la luminaria con un diámetro de Ø205 mm.

2. Sujetar los ganchos de fijación, ubicados en los laterales de la luminaria. Para insertar está en la perforación previamente realizada.

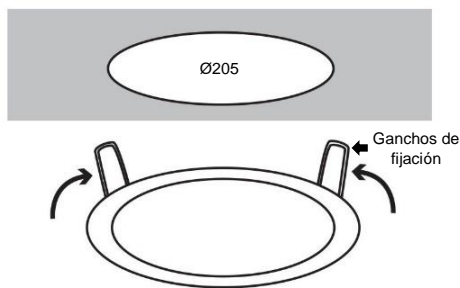

3. Soltar los ganchos una vez que se encuentre la luminaria dentro de la perforación del techo. Asegurarse que la luminaria quede ajustada en el techo.

Mantenimiento de las luminarias

Es esencial llevar a cabo periódicamente inspecciones y mantenimiento a las luminarias instaladas, ya que estas reciben influencia de las condiciones de operación y del medio donde se ubican.

1. Mantenimiento correctivo

El mantenimiento correctivo de las luminarias consiste en localizar, reparar y adecuar las instalaciones para que funcionen el máximo número de horas posible, con el desempeño para el que fueron diseñadas.

Las actividades que componen el mantenimiento correctivo son:

- Localización y reparación de averías
- Adecuación de instalaciones

Para la ejecución del mantenimiento correctivo es importante tener en cuenta los siguientes aspectos:

- Si se genera algún inconveniente en el módulo LED por favor comunicarse con la empresa.
- Revisar el encendido, apagado y el correcto funcionamiento de la luminaria.
- Limpiar el módulo LED y el conjunto óptico de las luminarias con aire comprimido. Para manipular la luminaria se recomienda utilizar guantes quirúrgicos.

2. Mantenimiento preventivo

Dentro de las técnicas de diagnóstico se deben considerar las mediciones eléctricas en diferentes puntos de la red, así como la medición de parámetros eléctricos de operación de las luminarias y sus componentes.

3. Mantenimiento de las instalaciones eléctricas de las luminarias

La persona encargada de la operación y el mantenimiento de las instalaciones eléctricas de las luminarias será responsable de mantenerlas en condiciones seguras, por lo tanto deben garantizar que se cumplan las disposiciones del reglamento que establece los requisitos que deben cumplir los sistemas de alumbrado y verificar que estas conexiones no presenten ningún riesgo para la salud o la vida de las personas, animales o el medio ambiente.

Light efficiency:



Light quality:



Color temperature:



Output: 3926 lm

Peak: 1565 cd

Power: 29,1 W

PF: 0,96



Product name:
E0016-K201-L35-PRO-4K

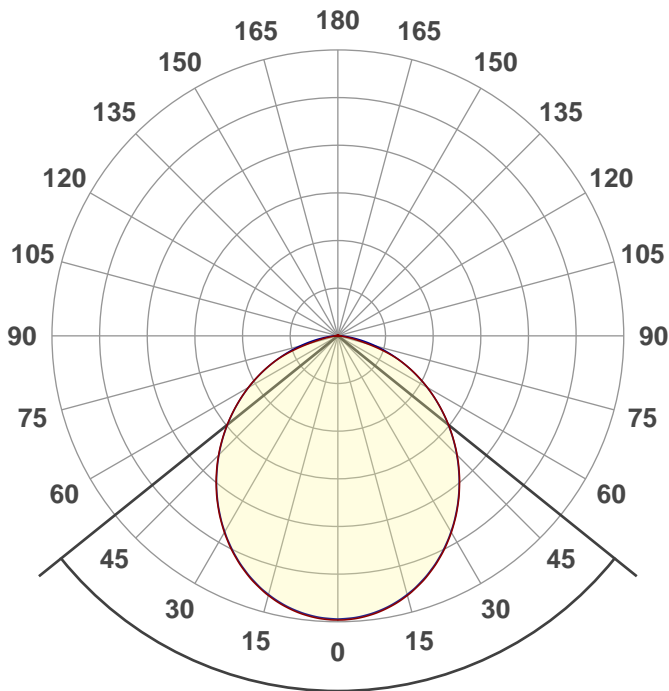

Beam angle **102,4°**



CIE 1931
x: 0,377
y: 0,371

THD Values:

Voltage: 2,66%

Current: 17,17%

Spectra

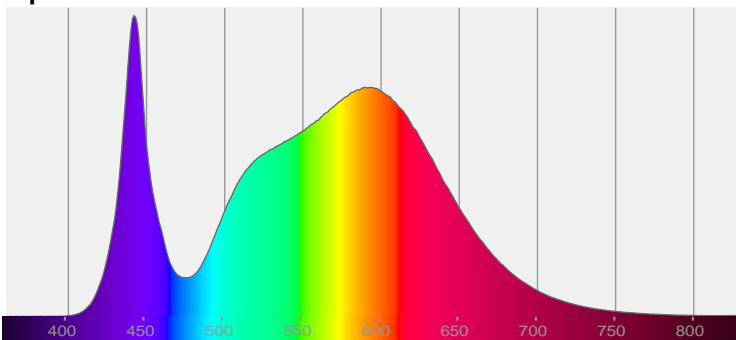

Power

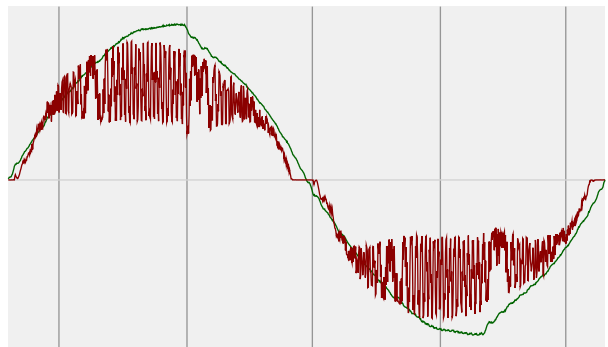

Voltage: 113 V
Current: 0,270 A
Frequency: 60 Hz

Color details

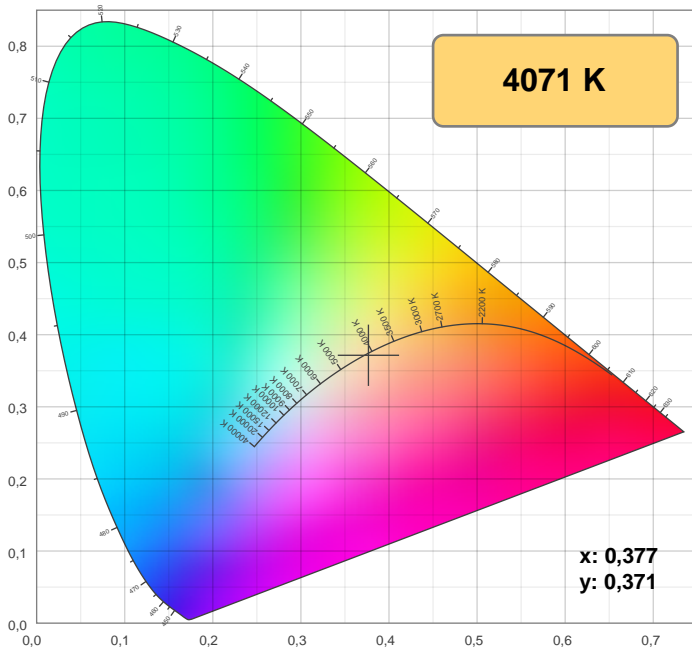

CIE 1931

CRI: 79,3 (R1-R8)

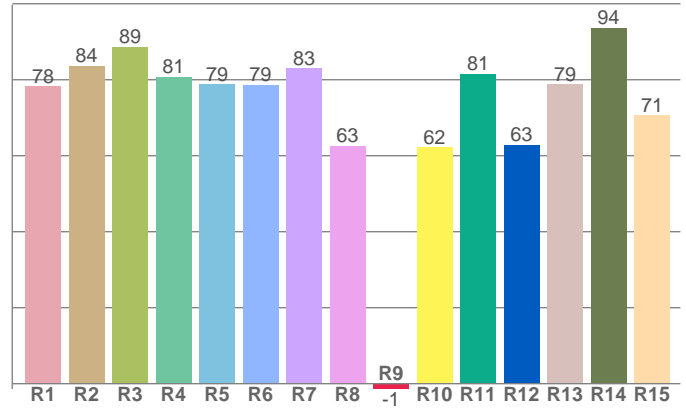

CRI R values, only R1-R8 are used to calculate final CRI value

R1	R2	R3	R4	R5	R6	R7	R8	9	R10	R11	R12	R13	R14	R15
78,2	83,5	88,7	80,8	78,7	78,7	82,9	62,6	-1,4	62,2	81,5	62,9	78,7	93,6	70,6

ISO Diagrams

ISO lux diagram

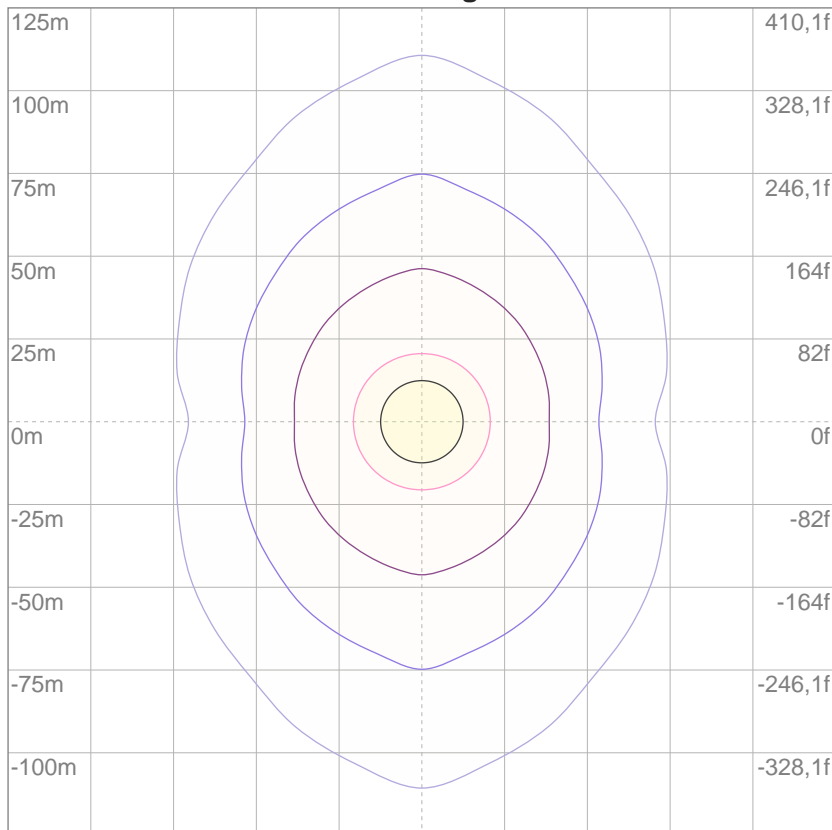

Mounting height: 10 meters (33 f)

- 3% 0,469 lx
- 5% 0,781 lx
- 10% 1,56 lx
- 30% 4,69 lx
- 50% 7,81 lx

Conditions:

Number of c-planes: 4

Lux at center: 15,6 lx

Lux distribution on a surface when lamp is mounted at 10 meters from the surface.

Beam details

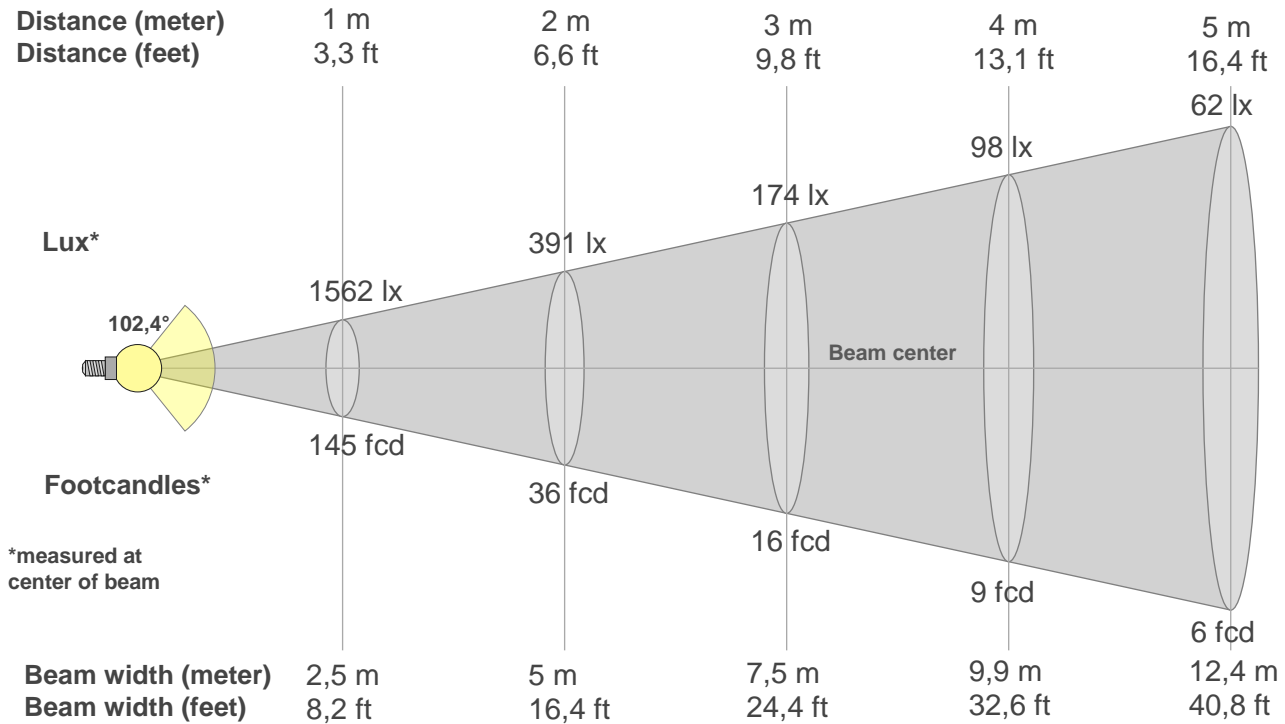

Beam intensities from 1-20m

1m	2m	3m	4m	5m	6m	7m	8m	9m	10m	11m	12m	13m	14m	15m	16m	17m	18m	19m	20m
3,3ft	6,6ft	9,8ft	13,1ft	16,4ft	19,7ft	23ft	26,2ft	29,5ft	32,8ft	36,1ft	39,4ft	42,7ft	45,9ft	49,2ft	52,5ft	55,8ft	59,1ft	62,3ft	65,6ft
1562lx	391lx	174lx	98lx	62lx	43lx	32lx	24lx	19lx	16lx	13lx	11lx	9lx	8lx	7lx	6lx	5lx	5lx	4lx	4lx
145,1fcd	36,3fcd	16,1fcd	9,1fcd	5,8fcd	4fcd	3fcd	2,3fcd	1,8fcd	1,5fcd	1,2fcd	1fcd	0,9fcd	0,7fcd	0,6fcd	0,6fcd	0,5fcd	0,4fcd	0,4fcd	0,4fcd

Intensities in 0° c-plane

0°	5°	10°	15°	20°	25°	30°	35°	40°	45°	50°	55°	60°	65°	70°	75°	80°	85°	90°	95°
1562	1555	1526	1480	1417	1339	1250	1150	1043	929	811	690	569	448	319	168	70	21	1	0
100%	100%	98%	95%	91%	86%	80%	74%	67%	59%	52%	44%	36%	29%	20%	11%	4%	1%	0%	0%

Intensities in 90° c-plane

0°	5°	10°	15°	20°	25°	30°	35°	40°	45°	50°	55°	60°	65°	70°	75°	80°	85°	90°	95°
1562	1549	1521	1474	1412	1335	1246	1147	1039	926	808	688	567	447	327	214	116	47	12	0
100%	99%	97%	94%	90%	85%	80%	73%	67%	59%	52%	44%	36%	29%	21%	14%	7%	3%	1%	0%

Intensities in 180° c-plane

0°	5°	10°	15°	20°	25°	30°	35°	40°	45°	50°	55°	60°	65°	70°	75°	80°	85°	90°	95°
1562	1555	1526	1480	1417	1339	1250	1150	1043	929	811	690	569	448	319	168	70	21	1	0
100%	100%	98%	95%	91%	86%	80%	74%	67%	59%	52%	44%	36%	29%	20%	11%	4%	1%	0%	0%

Intensities in 270° c-plane

0°	5°	10°	15°	20°	25°	30°	35°	40°	45°	50°	55°	60°	65°	70°	75°	80°	85°	90°	95°
1562	1549	1521	1474	1412	1335	1246	1147	1039	926	808	688	567	447	327	214	116	47	12	0
100%	99%	97%	94%	90%	85%	80%	73%	67%	59%	52%	44%	36%	29%	21%	14%	7%	3%	1%	0%

Beam angle 50%	Field angle 10%	Cutoff angle 2,5%	Intensity ratio in 120° cone	Intensity ratio in 90° cone
102,4°	153,2°	168,6°	82,2%	57,6%

TM30 details

Rf 76,8
Fidelity index Rf

Rg 99,1
Gammut index Rg

Hue Bin	R _f	Graphic shifts (%)	
		Chroma	Hue
1	77	-13%	-4%
2	77	-9%	8%
3	64	-4%	17%
4	72	5%	15%
5	78	12%	9%
6	82	11%	-1%
7	84	4%	-9%
8	83	-4%	-9%
9	84	-9%	-5%
10	75	-11%	6%
11	72	-3%	16%
12	73	5%	13%
13	84	11%	-1%
14	81	9%	-4%
15	76	2%	-16%
16	76	-4%	-14%

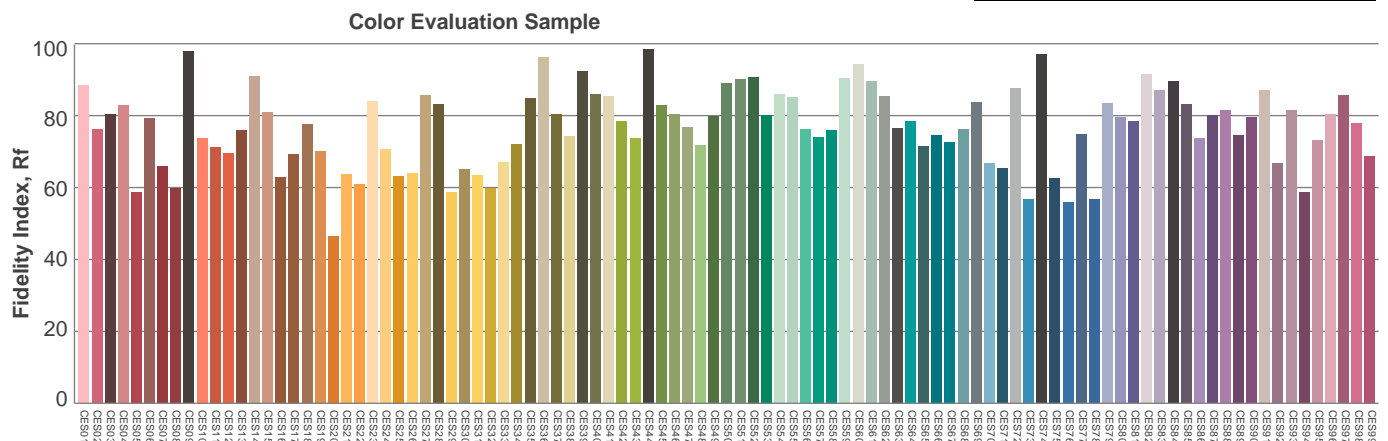
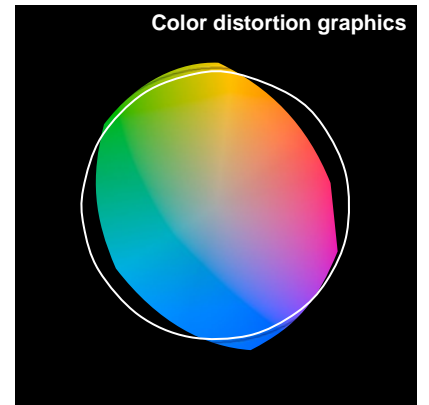
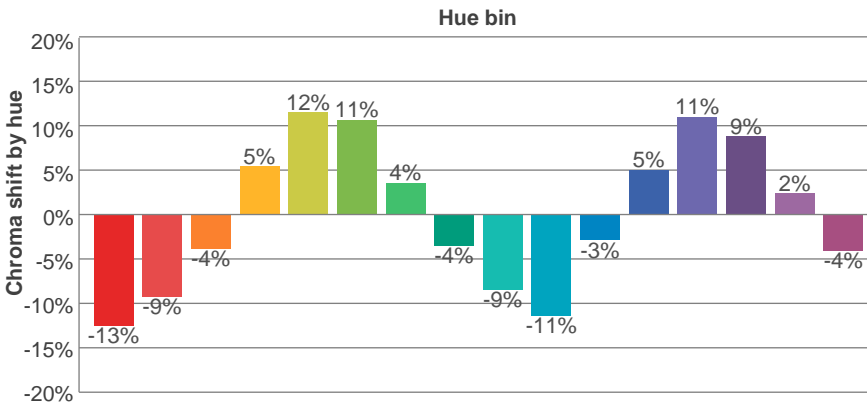
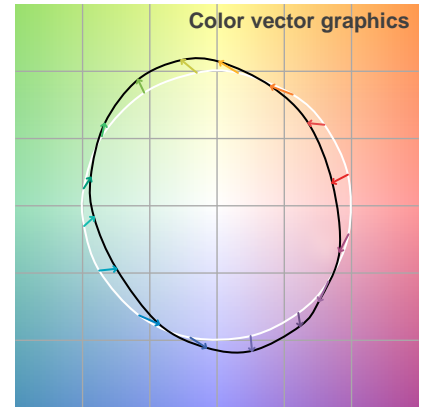
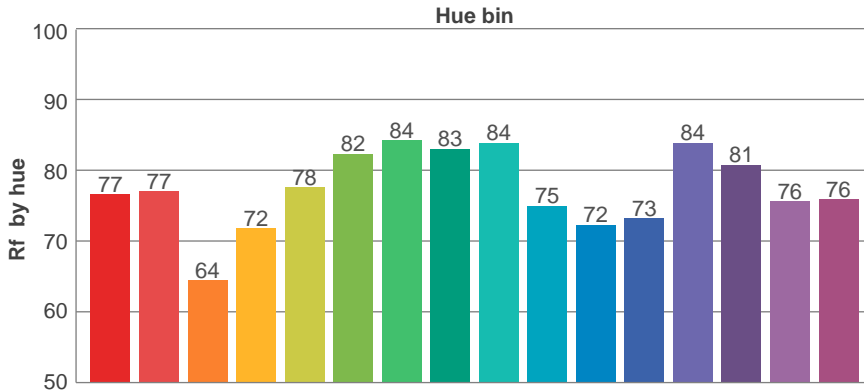
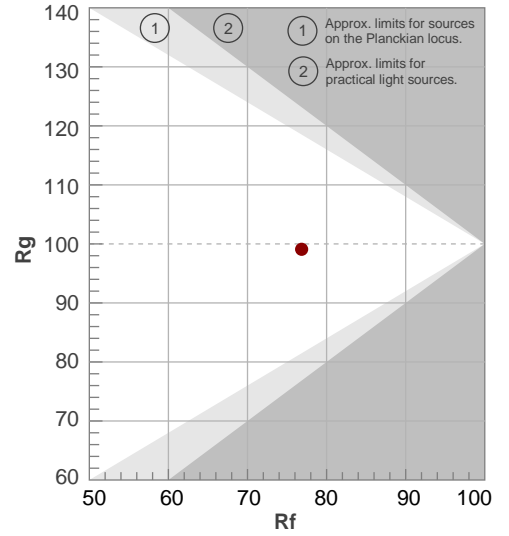

UGR

Glare Evaluation According to UGR

p Ceiling	70	70	50	50	30	70	70	50	50	30	
p Walls	50	30	50	30	30	50	30	50	30	30	
p Floor	20	20	20	20	20	20	20	20	20	20	
Room size X Y	Viewing direction at right angles to lamp axis					Viewing direction parallel to lamp axis					
2H	2H	26,1	27,4	26,4	27,6	27,9	26,1	27,4	26,4	27,6	27,9
	3H	27,4	28,6	27,8	28,9	29,1	27,5	28,6	27,8	28,9	29,1
	4H	27,8	28,9	28,1	29,1	29,4	27,9	29,0	28,3	29,3	29,6
	6H	27,9	28,9	28,3	29,2	29,5	28,2	29,2	28,6	29,5	29,8
	8H	27,9	28,9	28,3	29,2	29,5	28,3	29,3	28,7	29,6	29,9
	12H	27,9	28,8	28,3	29,1	29,5	28,3	29,3	28,7	29,6	29,9
4H	2H	26,8	27,8	27,1	28,1	28,4	26,7	27,8	27,1	28,1	28,4
	3H	28,2	29,1	28,6	29,5	29,8	28,2	29,2	28,6	29,5	29,8
	4H	28,7	29,5	29,1	29,8	30,2	28,8	29,6	29,2	30,0	30,3
	6H	28,8	29,5	29,3	29,9	30,3	29,2	29,9	29,6	30,3	30,7
	8H	28,9	29,5	29,3	29,9	30,3	29,3	29,9	29,7	30,3	30,8
	12H	28,9	29,4	29,3	29,9	30,3	29,4	29,9	29,8	30,4	30,8
8H	4H	28,8	29,5	29,3	29,9	30,3	29,0	29,6	29,4	30,0	30,4
	6H	29,1	29,6	29,5	30,0	30,5	29,4	30,0	29,9	30,4	30,9
	8H	29,2	29,6	29,6	30,1	30,5	29,6	30,1	30,1	30,5	31,0
	12H	29,2	29,6	29,7	30,0	30,5	29,7	30,1	30,2	30,6	31,1
12H	4H	28,8	29,4	29,3	29,8	30,3	29,0	29,6	29,4	30,0	30,4
	6H	29,1	29,6	29,6	30,0	30,5	29,5	29,9	29,9	30,4	30,8
	8H	29,2	29,6	29,7	30,0	30,5	29,6	30,0	30,1	30,5	31,0
Variation of the observer position for the luminaire distance S											
S = 1,0H	+0,1 / -0,2					+0,1 / -0,2					
S = 1,5H	+0,3 / -0,6					+0,3 / -0,5					
S = 2,0H	+0,6 / -1,0					+0,5 / -0,9					
Standard table	BK04					BK05					
Correction summand	11,7					12,3					
Corrected glare indices referring to 3926 lm total luminous flux											

Light planning

Coefficients of Utilization

Ceiling reflectance	80				70				50			30			10			0			
Wall reflectance	70	50	30	10	70	50	30	10	50	30	10	50	30	10	50	30	10	0			
Floor reflectance	20	20	20	20	20	20	20	20	20	20	20	20	20	20	20	20	20	20	20	20	0
RCR	(RCR: Room Cavity Ratio)																				
	Room Values are expressed as percentage of Lumens delivered to the task surface																				
0	119	119	119	119	116	116	116	116	111	111	111	106	106	106	102	102	102	100	100		
1	109	105	101	97	107	103	99	96	98	95	93	95	92	90	91	89	87	85	85		
2	100	92	86	80	97	90	84	79	87	82	77	83	79	76	80	77	74	72	72		
3	91	81	73	67	89	80	72	67	77	70	65	74	69	64	71	67	63	61	61		
4	84	72	64	57	82	71	63	57	68	62	56	66	60	55	64	59	55	52	52		
5	77	65	56	50	75	64	55	49	62	54	49	60	53	48	58	52	48	46	46		
6	71	58	50	43	70	58	49	43	56	48	43	54	47	42	52	47	42	40	40		
7	66	53	45	39	65	52	44	38	51	43	38	49	43	38	48	42	38	36	36		
8	62	49	40	34	60	48	40	34	47	39	34	45	39	34	44	38	34	32	32		
9	58	45	37	31	56	44	36	31	43	36	31	42	35	31	41	35	31	29	29		
10	54	41	33	28	53	41	33	28	40	33	28	39	32	28	38	32	28	26	26		

LAMPS (number of lamps)

Luminaire budgetary diagram

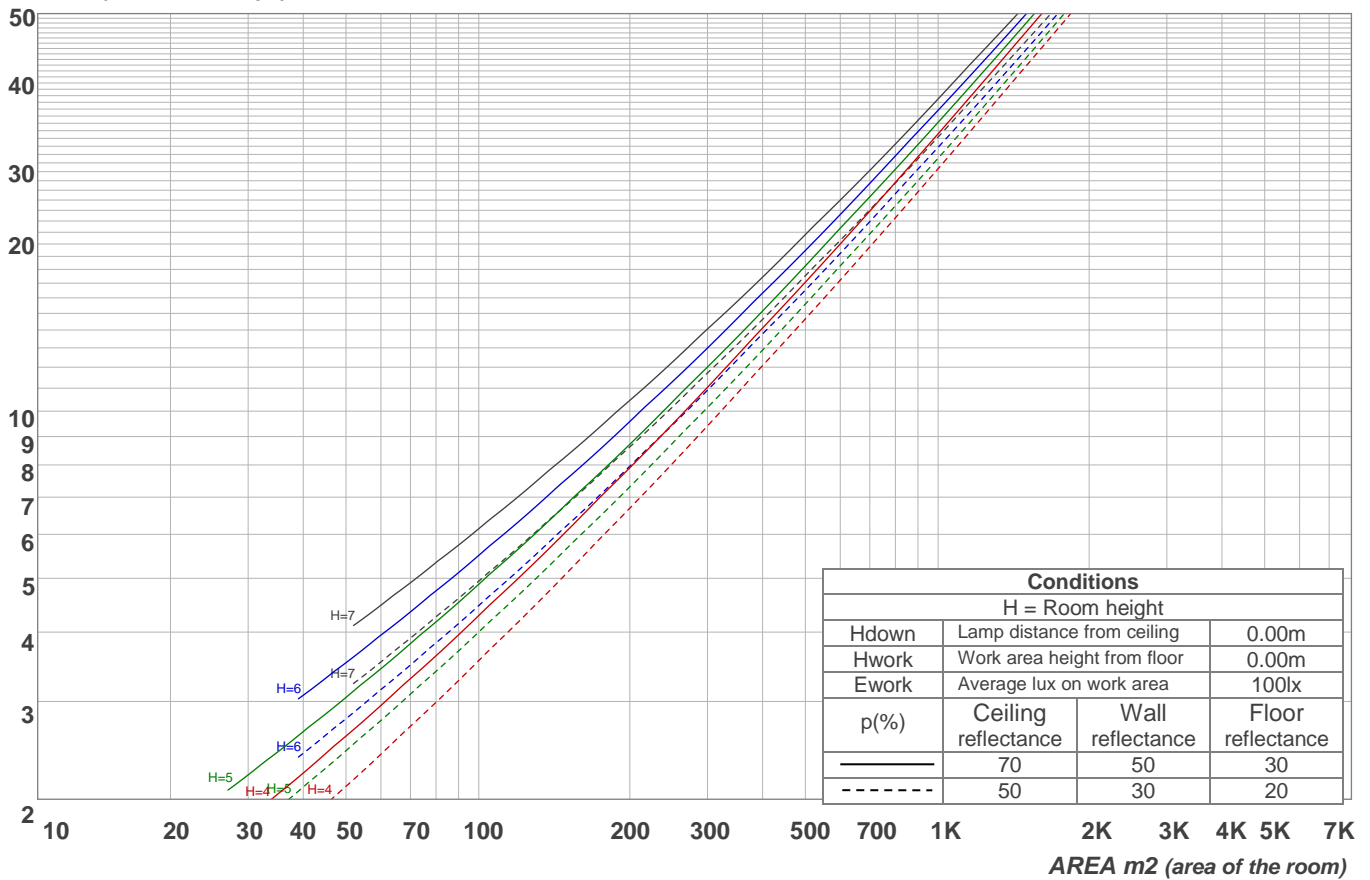

Zonal Lumen Summary

0°-10°	10°-20°	20°-30°	30°-40°	40°-50°	50°-60°	60°-70°	70°-80°	80°-90°
147 lm	416 lm	616 lm	718 lm	715 lm	616 lm	442 lm	208 lm	42,4 lm
90°-100°	100°-110°	110°-120°	120°-130°	130°-140°	140°-150°	150°-160°	160°-170°	170°-180°
1,27 lm	0,532 lm	0,694 lm	0,820 lm	0,871 lm	0,784 lm	0,589 lm	0,384 lm	0,136 lm

Stabilization

Warmup curve

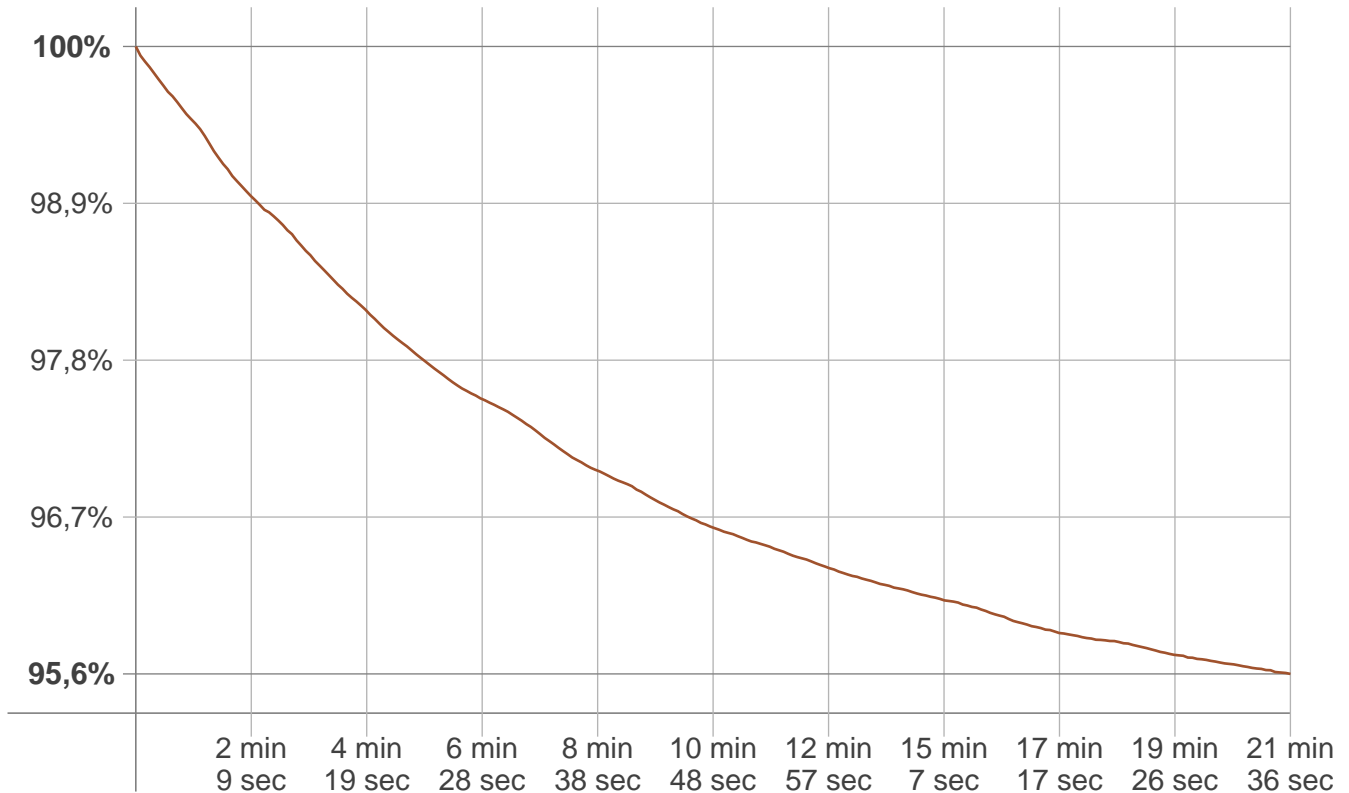

Warmup result

Warmup time:	21 min 36 sec
Warmup variation	-4,4%

Warmup conditions

Stable period:	15 min
Stable change max:	2,0%
Minimum time:	15 min

Color temperature change

CCT start	CCT change	CCT end
4033 K	+38 K	4071 K

Output change

Output start	Output change	Output end
4100 lm	-174 lm	3926 lm