

Luminaria para exterior

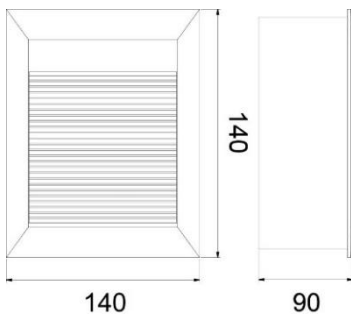

Dimensiones (mm)

Largo: 140; **Ancho:** 140
Alto: 90.



Código

KT533

Descripción

Luminaria tipo Step Light, diseñada con módulo de LED integrado. Housing con textura estriada y con difusor transparente.



Materiales y acabado

Cuerpo en aluminio inyectado con acabado en pintura poliéster electrostática texturizada.

Color

Gris.

Características técnicas

LED	 59°	 20,000h	IP 54	IK 04
PF 0,46	THD <50%	°C 0-55	V 110-127	Clase II

Fuente de luz

Módulo de LED.

Potencia Nominal	CRI	K	Lm / W	Lm de Salida
1,68W	>80	4000	63	25,3

Características de fuente de luz

- Color temperatura disponible 4000K (neutro).
- Potencia de Salida: 0,4W.

Light efficiency:



Light quality:



Color temperature:



Output: 25,3 lm

Peak: 36,1 cd

Power: 0,40 W

PF: 0,46



Product name:
E0203-KT533

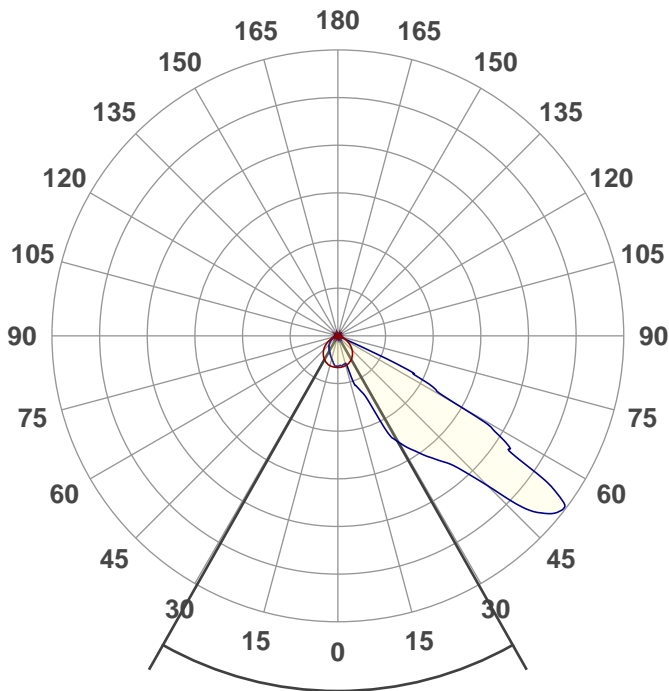

Beam angle **59°**



CIE 1931
x: 0,379
y: 0,381

THD Values:

Voltage: 2,72%

Current: 49,34%

Spectra

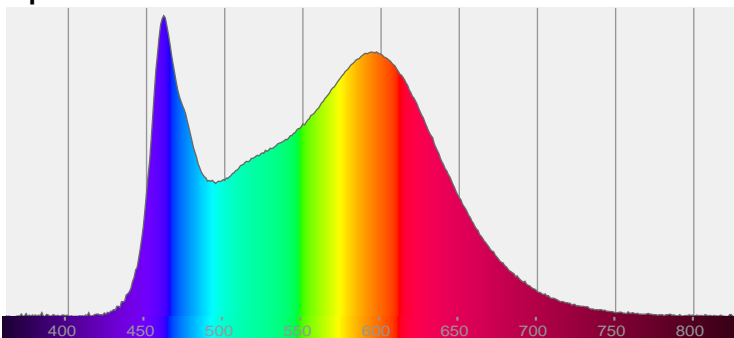

Power

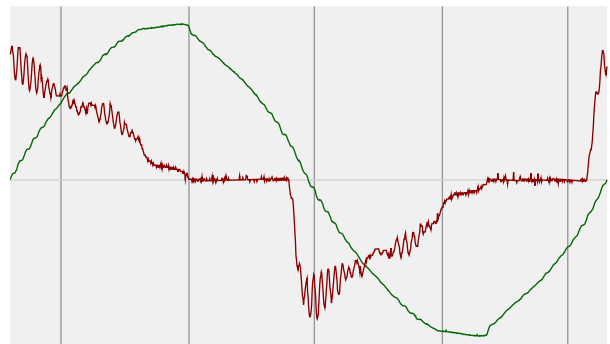

Voltage: 115 V
Current: 0,008 A
Frequency: 60 Hz

Color details

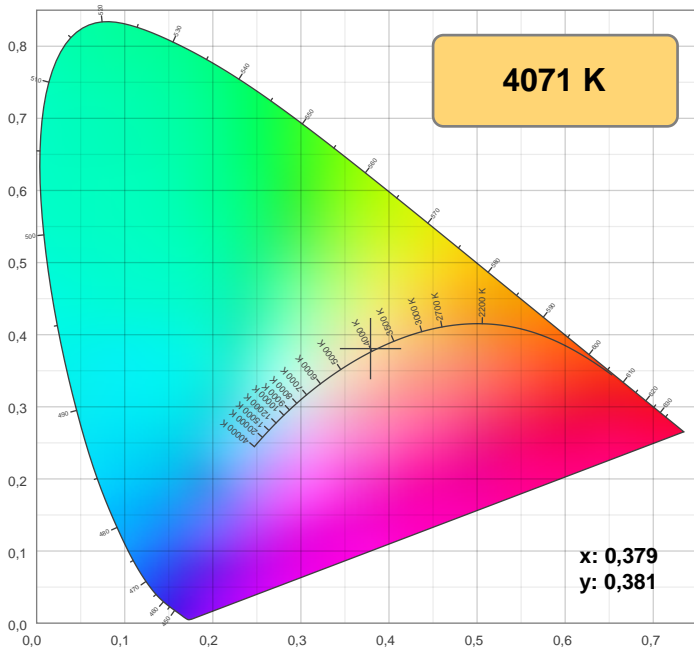

CIE 1931

CRI: 82,4 (R1-R8)

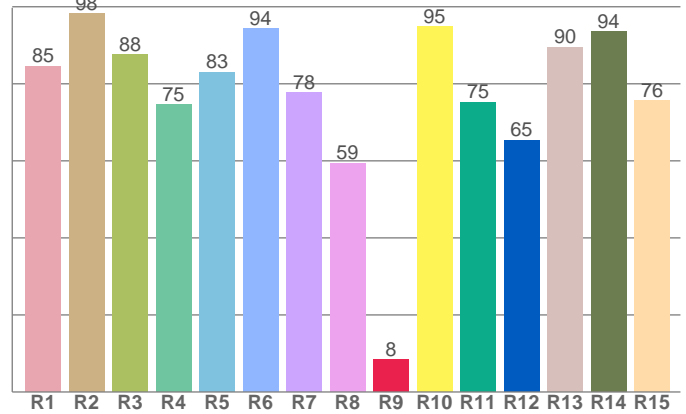

CRI R values, only R1-R8 are used to calculate final CRI value

R1	R2	R3	R4	R5	R6	R7	R8	9	R10	R11	R12	R13	R14	R15
84,5	98,2	87,6	74,5	82,9	94,3	77,6	59,4	8,4	94,8	75,2	65,3	89,5	93,5	75,6

ISO Diagrams

ISO lux diagram

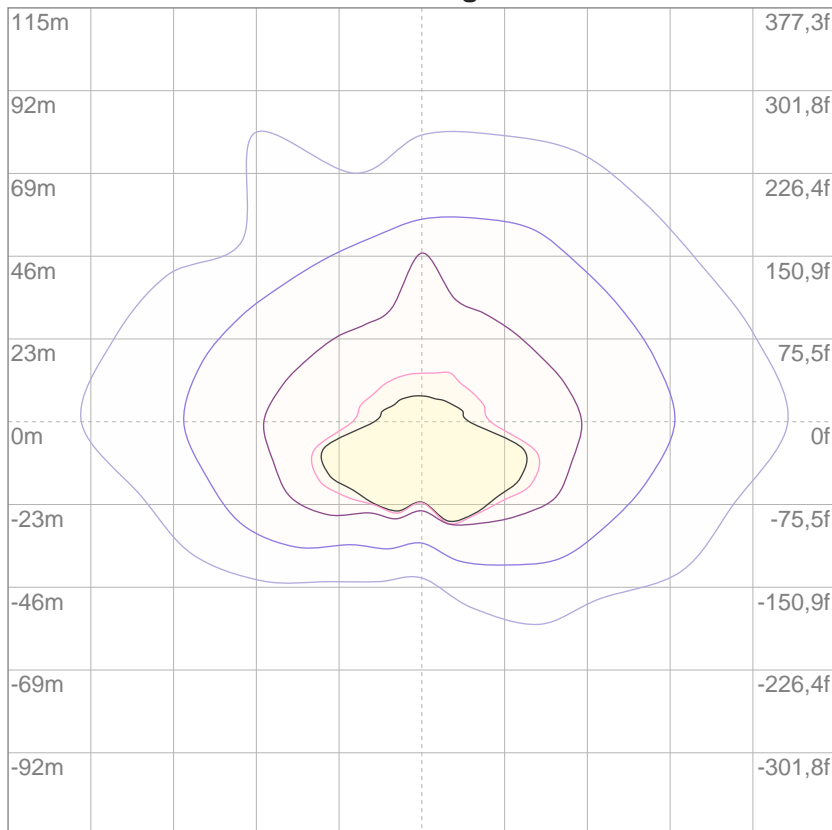

Mounting height: 10 meters (33 f)

- 3% 1,18m lx
- 5% 1,97m lx
- 10% 3,93m lx
- 30% 11,8m lx
- 50% 19,7m lx

Conditions:

Number of c-planes: 12

Lux at center: 39,3m lx

Lux distribution on a surface when lamp is mounted at 10 meters from the surface.

Beam details

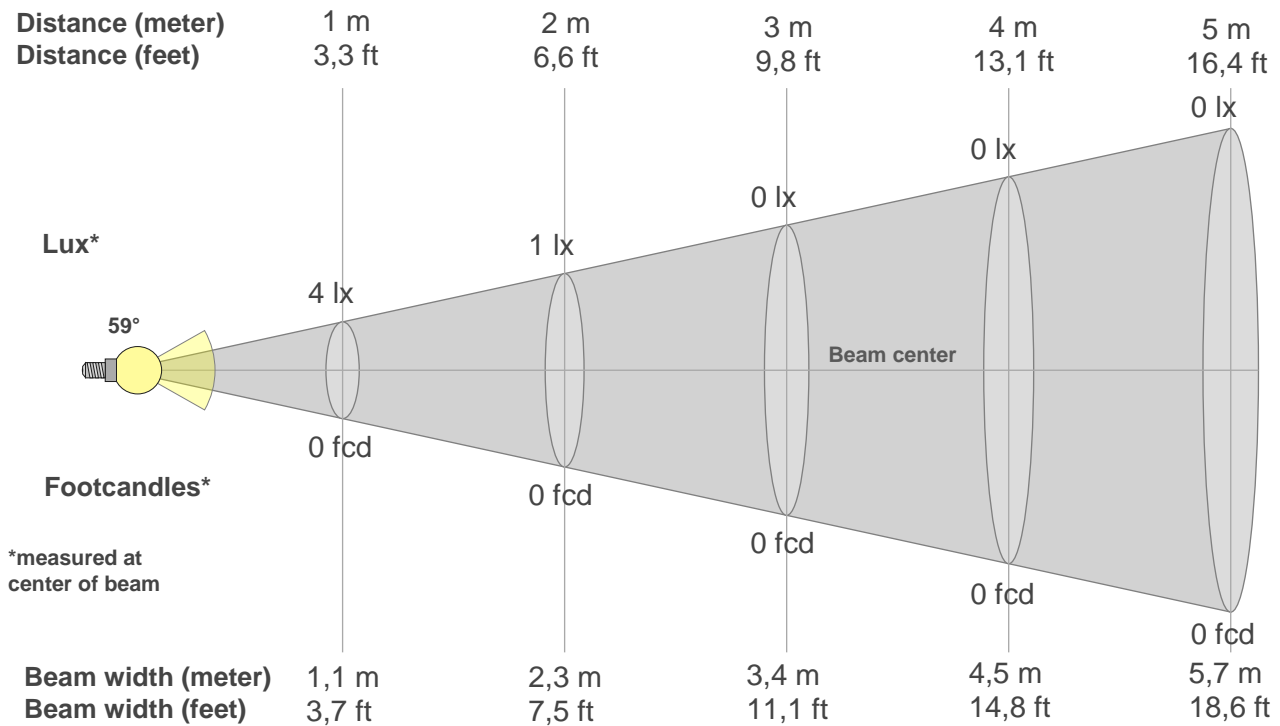

Beam intensities from 1-20m

1m	2m	3m	4m	5m	6m	7m	8m	9m	10m	11m	12m	13m	14m	15m	16m	17m	18m	19m	20m
3,3ft	6,6ft	9,8ft	13,1ft	16,4ft	19,7ft	23ft	26,2ft	29,5ft	32,8ft	36,1ft	39,4ft	42,7ft	45,9ft	49,2ft	52,5ft	55,8ft	59,1ft	62,3ft	65,6ft
4lx	1lx	0lx	0lx	0lx	0lx	0lx	0lx	0lx	0lx	0lx	0lx	0lx	0lx	0lx	0lx	0lx	0lx	0lx	0lx
0,4fcd	0,1fcd	0fcd	0fcd	0fcd	0fcd	0fcd	0fcd	0fcd	0fcd	0fcd	0fcd	0fcd	0fcd	0fcd	0fcd	0fcd	0fcd	0fcd	0fcd

Intensities in 0° c-plane

0°	5°	10°	15°	20°	25°	30°	35°	40°	45°	50°	55°	60°	65°	70°	75°	80°	85°	90°	95°
3,93	4,01	3,97	3,89	3,80	3,63	3,43	3,17	2,89	2,58	2,20	1,81	1,39	1,03	0,77	0,51	0,26	0,08	0,01	0,00
100%	102%	101%	99%	96%	92%	87%	81%	74%	65%	56%	46%	35%	26%	20%	13%	7%	2%	0%	0%

Intensities in 90° c-plane

0°	5°	10°	15°	20°	25°	30°	35°	40°	45°	50°	55°	60°	65°	70°	75°	80°	85°	90°	95°
3,9	3,8	3,7	3,6	6,8	9,0	15,7	18,2	20,9	27,0	35,1	32,4	18,3	5,8	0,3	0,2	0,1	0,0	0,0	0,0
100%	96%	95%	93%	172%	229%	399%	463%	532%	687%	893%	823%	466%	149%	8%	4%	2%	0%	0%	0%

Intensities in 180° c-plane

0°	5°	10°	15°	20°	25°	30°	35°	40°	45°	50°	55°	60°	65°	70°	75°	80°	85°	90°	95°
3,93	4,01	3,97	3,92	3,80	3,65	3,44	3,17	2,88	2,54	2,19	1,79	1,38	1,01	0,76	0,51	0,27	0,09	0,01	0,00
100%	102%	101%	100%	97%	93%	87%	81%	73%	65%	56%	46%	35%	26%	19%	13%	7%	2%	0%	0%

Intensities in 270° c-plane

0°	5°	10°	15°	20°	25°	30°	35°	40°	45°	50°	55°	60°	65°	70°	75°	80°	85°	90°	95°
3,93	3,84	3,41	3,04	2,66	2,39	2,20	1,99	1,74	1,51	1,32	1,14	0,93	0,70	0,52	0,35	0,19	0,07	0,01	0,01
100%	98%	87%	77%	68%	61%	56%	51%	44%	38%	34%	29%	24%	18%	13%	9%	5%	2%	0%	0%

Beam angle 50%	Field angle 10%	Cutoff angle 2,5%	Intensity ratio in 120° cone	Intensity ratio in 90° cone
59°	114,8°	148,7°	81,6%	38,1%

TM30 details

Rf 76,3
Fidelity index Rf

Rg 86,8
Gammut index Rg

Hue Bin	R _f	Graphic shifts (%)	
		Chroma	Hue
1	72	-13%	4%
2	82	-6%	5%
3	87	-5%	3%
4	84	-7%	-4%
5	79	-14%	-4%
6	79	-12%	-1%
7	74	-15%	6%
8	73	-10%	12%
9	69	-4%	20%
10	69	1%	18%
11	80	8%	8%
12	84	5%	-7%
13	74	2%	-20%
14	76	-6%	-11%
15	66	-10%	-17%
16	68	-12%	-8%

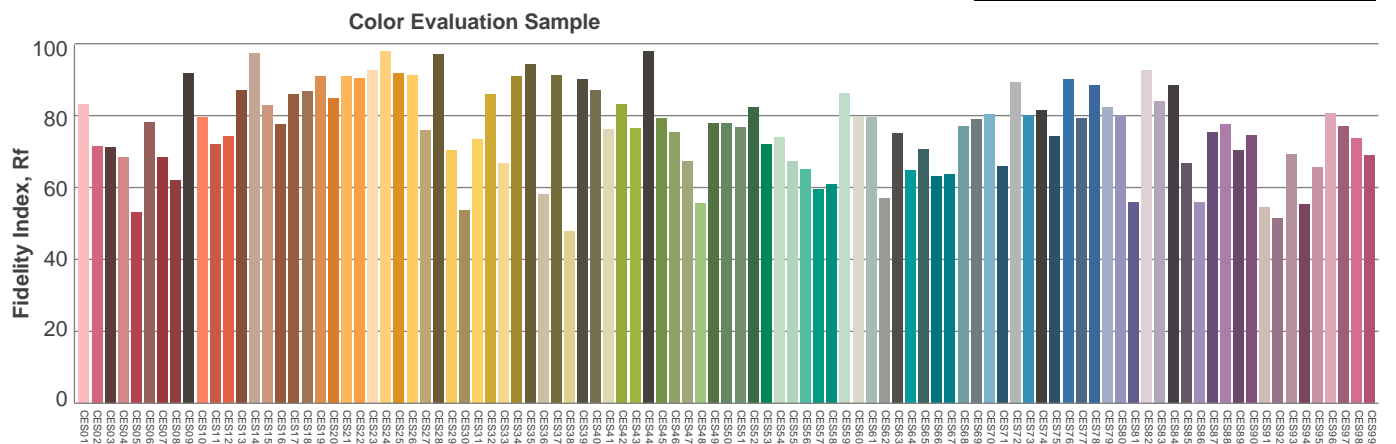
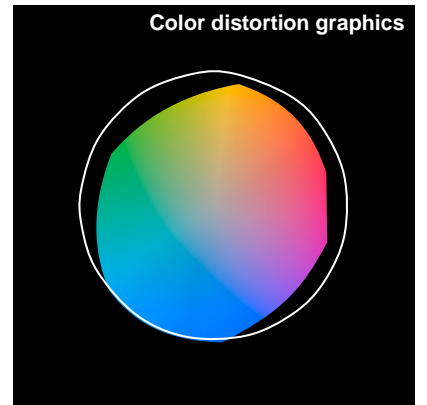
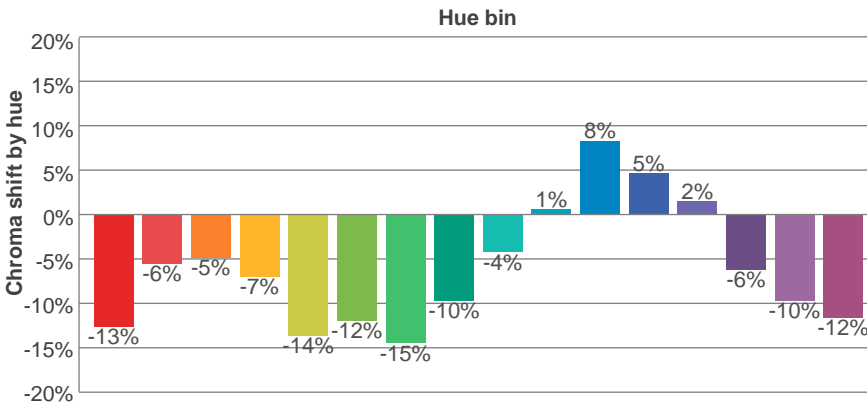
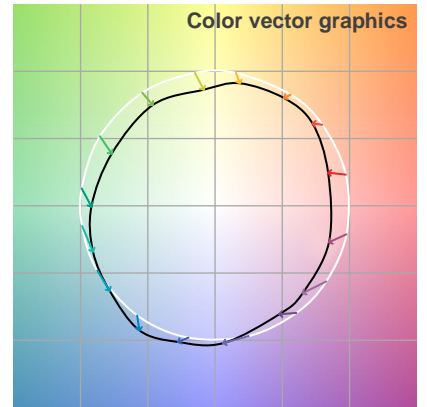
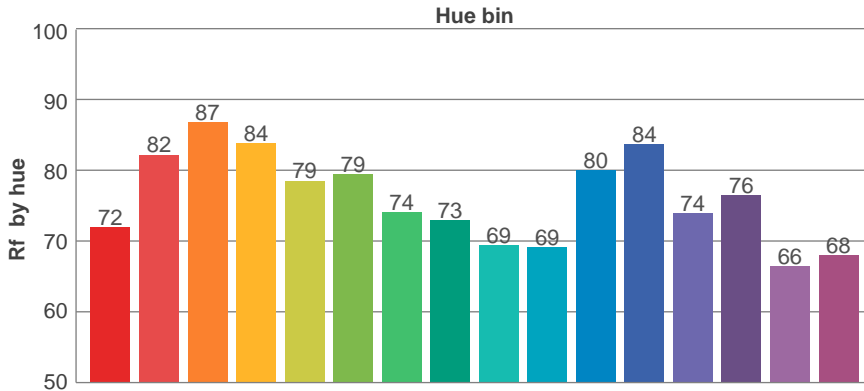
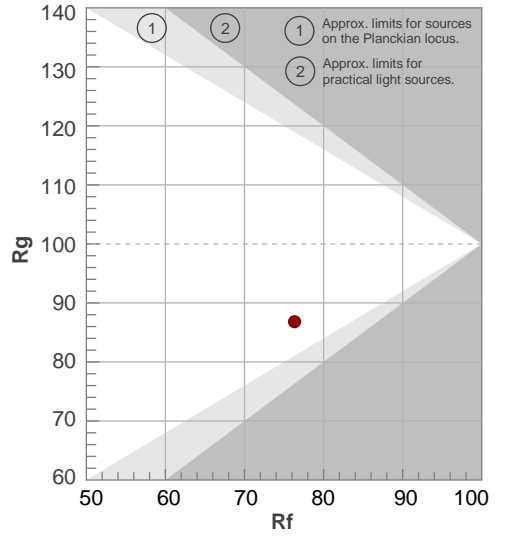

Stabilization

Warmup curve

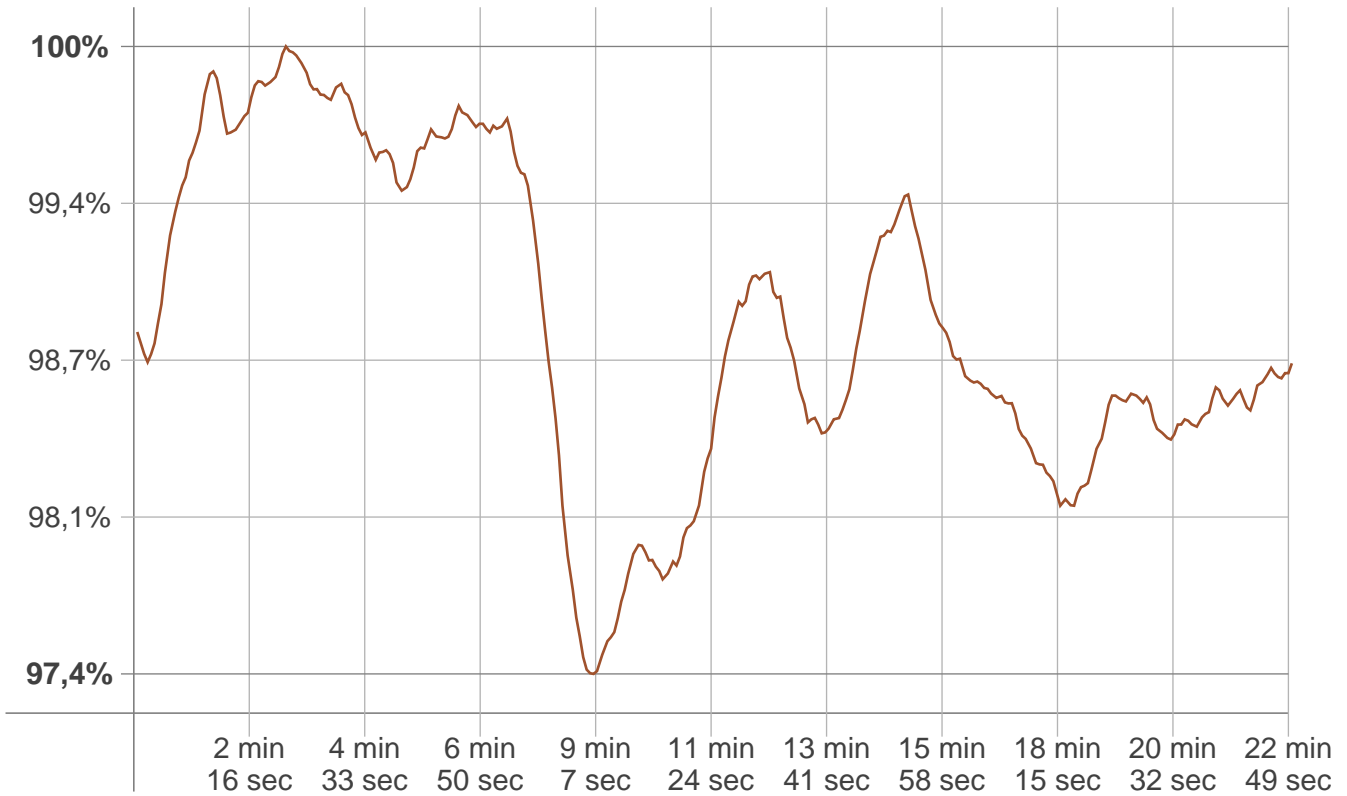

Warmup result

Warmup time:	22 min 53 sec
Warmup variation	-2,6%

Warmup conditions

Stable period:	15 min
Stable change max:	2,0%
Minimum time:	15 min

Color temperature change

CCT start	CCT change	CCT end
4064 K	+7 K	4071 K

Output change

Output start	Output change	Output end
25,3 lm	-0,1 lm	25,3 lm