

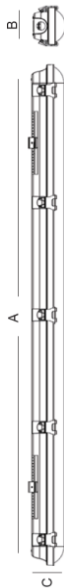

Dimensiones (mm)

A: 1200; **B:** 80
C: 76.



Código

V32E-LED-40W-5K

Descripción

Luminaria tipo hermética, diseñada con módulos de LED. Sobrepuesta o descolgada al techo por medio de sujetadores. Compuesta por un difusor en policarbonato opal y anti deslumbrante.



Materiales y acabado

Chasis y difusor en policarbonato inyectado.

Color

Cuerpo: Gris.

Características técnicas

LED	 123°	 50,000h	IP 65	IK 08	LM 80
V 120-277	°C -30-50	DIM 0-10V	PF 0,98	THD <15%	2Kv Surge Protection

Fuente de luz

Módulos LED.

Potencia Nominal	CRI	K	Lm / W	Lm Nominales
40W	>80	5000	114	3843

Características de fuente de luz

- Color temperatura disponible 5000K (luz día).
- Potencia de Salida: 33,7W.

Instalación

Adosada

Se debe tener en cuenta la alimentación de la luminaria, para ubicarla.

1. Realizar las perforaciones en la losa para instalar los chazos, agregándole pega Sika expansiva; seguir indicaciones del fabricante de la pega.

La pega debe ir dentro del agujero en donde se ubicarán los chazos, con el fin de generar un mejor agarre, previniendo desplome por posibles vibraciones.

2. Ubicar los dos sujetadores y asegurar con los tornillos correspondientes al chazo. Se debe tener en cuenta la distancia en donde encaja la luminaria con los sujetadores para realizar una correcta instalación.

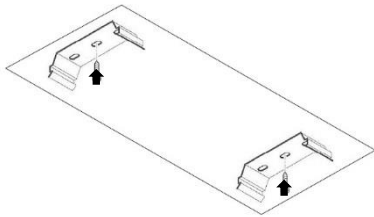

3. Ubicar la luminaria dentro de los sujetadores, hasta que está haga "click".

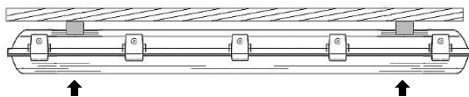

3. Retirar el difusor para realizar la conexión eléctrica.

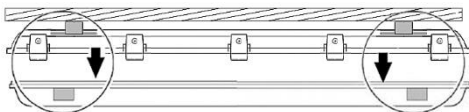

4. Colocar nuevamente el difusor.

Suspendida

Se debe tener en cuenta la alimentación de la luminaria, para ubicarla.

1. Perforar y situar los chazos expansivos a la losa. Se debe tener en cuenta la distancia en donde encaja la luminaria.

2. Asegurar con tuerca y contra tuerca una varilla roscada de 3/8" en medio de cada uno de los sujetadores.

3. Colocar cada una de las varillas roscadas a los chazos ubicados en la losa.

4. Ubicar la luminaria dentro de los sujetadores, hasta que está haga "click".

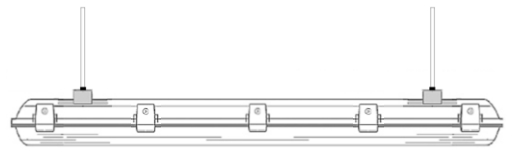

5. Retirar el difusor para realizar la conexión eléctrica.

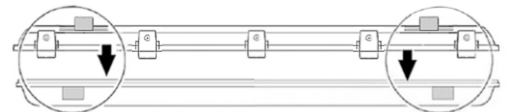

6. Colocar nuevamente el difusor.

Nota 1: Prestar atención al momento de instalar, el difusor. Este debe quedar en medio de la pestaña del cuerpo; haciéndole presión al empaque. De esta manera se garantiza el IP.

Nota 2: Distecsa garantiza el buen y correcto funcionamiento del sistema eléctrico antes de ser instalado, algún retroceso o falla en el sistema corre por parte del personal de instalación.

Mantenimiento de las luminarias

Es esencial llevar a cabo periódicamente inspecciones y mantenimiento a las luminarias instaladas, ya que estas reciben influencia de las condiciones de operación y del medio donde se ubican.

1. Mantenimiento correctivo

El mantenimiento correctivo de las luminarias consiste en localizar, reparar y adecuar las instalaciones para que funcionen el máximo número de horas posible, con el desempeño para el que fueron diseñadas.

Las actividades que componen el mantenimiento correctivo son:

- Localización y reparación de averías
- Adecuación de instalaciones

Para la ejecución del mantenimiento correctivo es importante tener en cuenta los siguientes aspectos:

- Reemplazar las bombillas en donde sea necesario, cerciorarse que el casquillo de la bombilla este perfectamente adaptado o coincida con el portalámparas.
- Revisar el encendido, apagado y el correcto funcionamiento de la luminaria.
- Cerciorarse de manipular la luminaria con las manos limpias, se recomienda utilizar guantes quirúrgicos.

2. Mantenimiento preventivo

Dentro de las técnicas de diagnóstico se deben considerar las mediciones eléctricas en diferentes puntos de la red, así como la medición de parámetros eléctricos de operación de las luminarias y sus componentes.

3. Mantenimiento de las instalaciones eléctricas de las luminarias

La persona encargada de la operación y el mantenimiento de las instalaciones eléctricas de las luminarias será responsable de mantenerlas en condiciones seguras, por lo tanto deben garantizar que se cumplan las disposiciones del reglamento que establece los requisitos que deben cumplir los sistemas de alumbrado y verificar que estas conexiones no presenten ningún riesgo para la salud o la vida de las personas, animales o el medio ambiente.

Light efficiency:



Light quality:



Color temperature:



Output: 3843 lm

Peak: 1055 cd

Power: 33,7 W

PF: 0,98



Product name:
E0828-V32E-LED-40W-5K

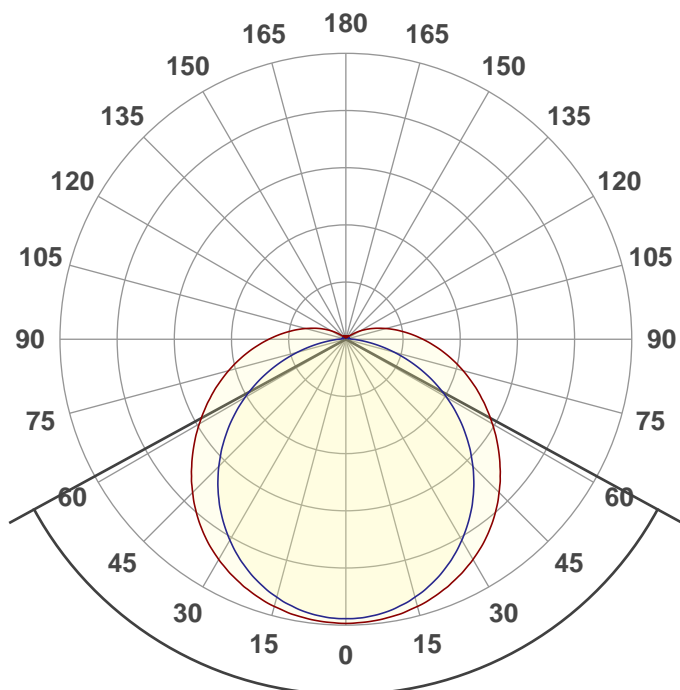

Beam angle **122,7°**



CIE 1931
x: 0,350
y: 0,361

THD Values:

Voltage: 2,35%

Current: 12,02%

Spectra

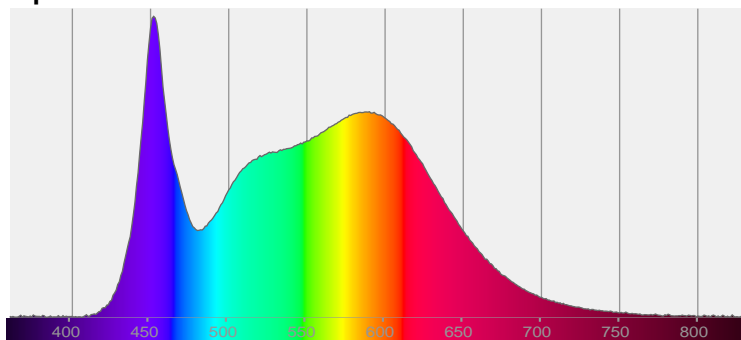

Power

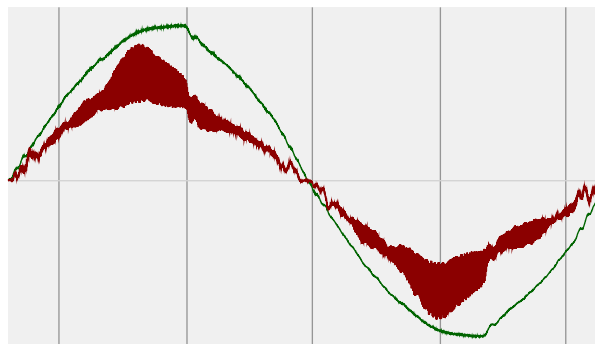

Voltage: 111 V
Current: 0,309 A
Frequency: 60,1 Hz

ISO Diagrams

ISO lux diagram

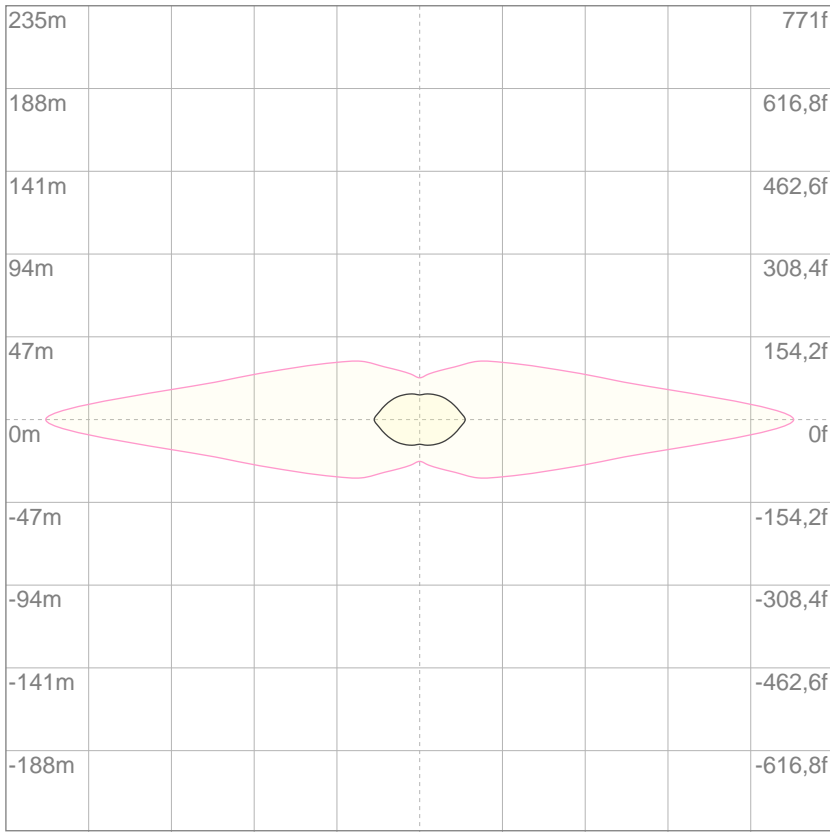

— 3%	0,314 lx
— 5%	0,523 lx
— 10%	1,05 lx
— 30%	3,14 lx
— 50%	5,23 lx

Conditions:
 Number of c-planes: 8
 Lux at center: 10,5 lx

Lux distribution on a surface when lamp is mounted at 10 meters from the surface.

Mounting height: 10 meters (33 f)

Color details

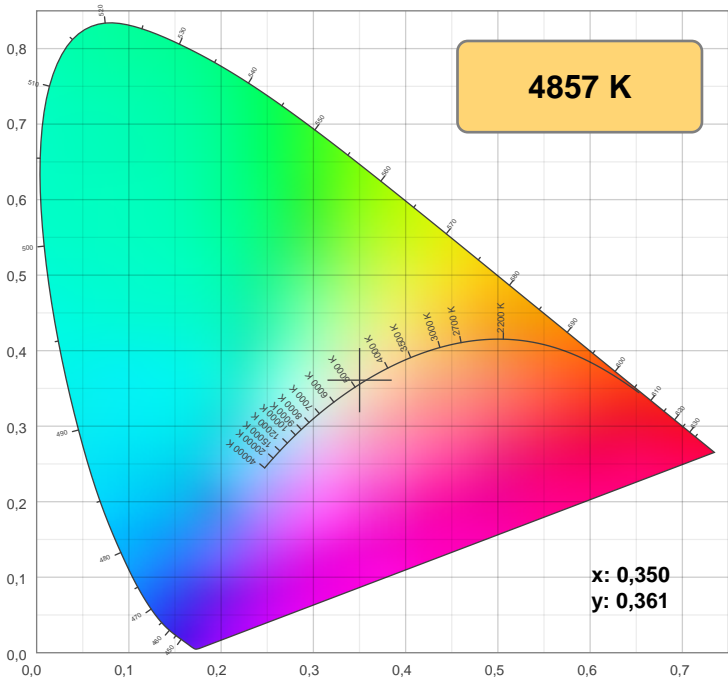

CIE 1931

CRI: 83,3 (R1-R8)

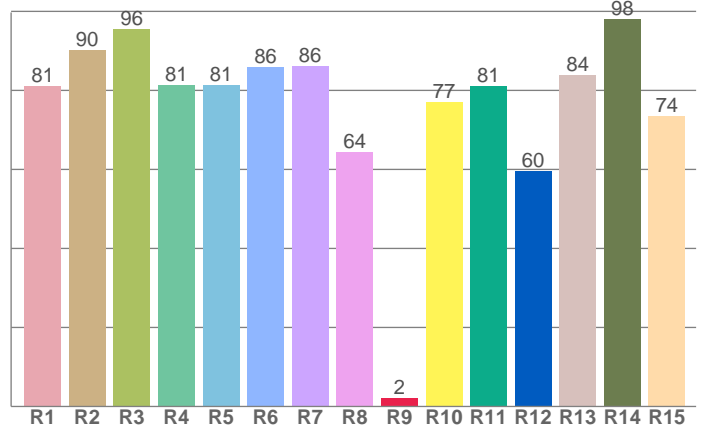

CRI R values, only R1-R8 are used to calculate final CRI value

R1	R2	R3	R4	R5	R6	R7	R8	R9	R10	R11	R12	R13	R14	R15
81,2	90,3	95,5	81,3	81,4	86,0	86,1	64,3	2,2	77,0	81,1	59,5	84,0	98,0	73,5

Color parameters

Color temperature	Color rendering index	Red component	Color fidelity	Color gamut	Color quality scale	Color coordinate cie 1931	Color coordinate cie 1931	Color coordinate	Color coordinate	Color deviation from black body
CCT	CRI	CRI R9	TM30 Rf	TM30 Rg	CQS	x	y	u	v	Δuv
4857 K	83,3	2,2	84,2	94,5	82,1	0,350	0,361	0,211	0,327	0,0027

TM-30 details

Rf 84,2
Fidelity index Rf

Rg 94,5
Gamut index Rg

Hue Bin	R _f	Shifts (%)	
		Chroma	Hue
1	77	-13%	0%
2	85	-8%	6%
3	79	-4%	11%
4	89	-1%	6%
5	91	-1%	3%
6	95	1%	-2%
7	91	-5%	-2%
8	89	-6%	1%
9	86	-7%	7%
10	78	-4%	13%
11	79	3%	13%
12	86	6%	5%
13	86	7%	-9%
14	85	2%	-8%
15	75	1%	-22%
16	78	-8%	-10%

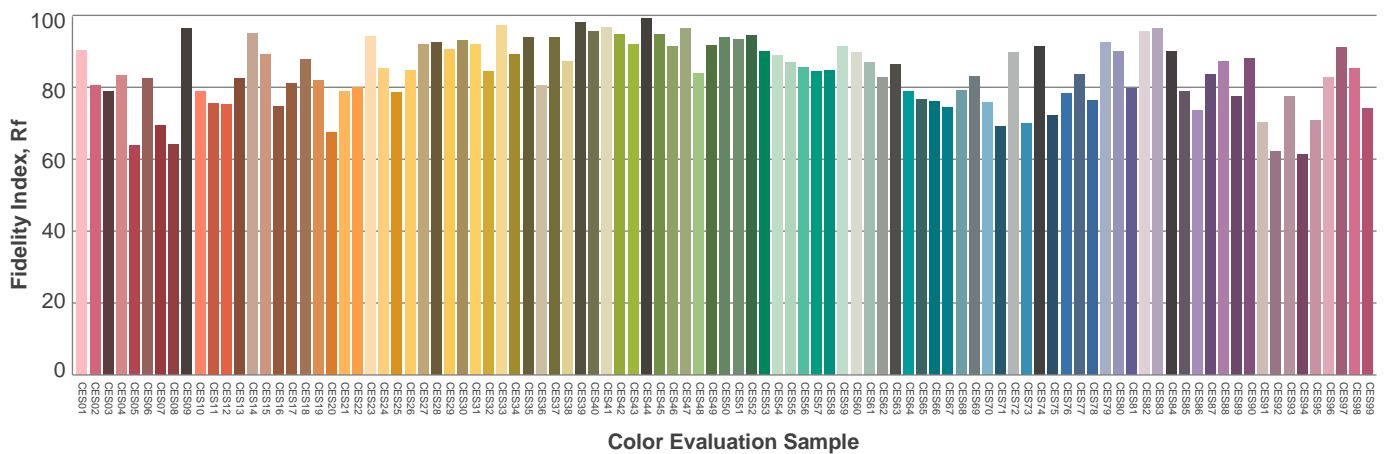
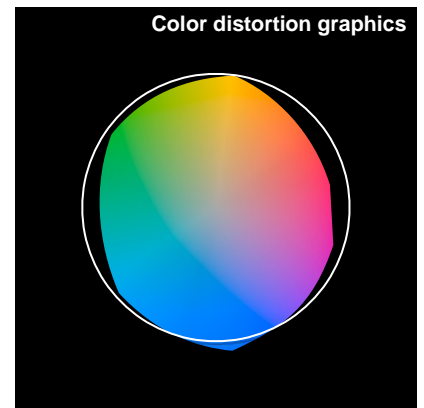
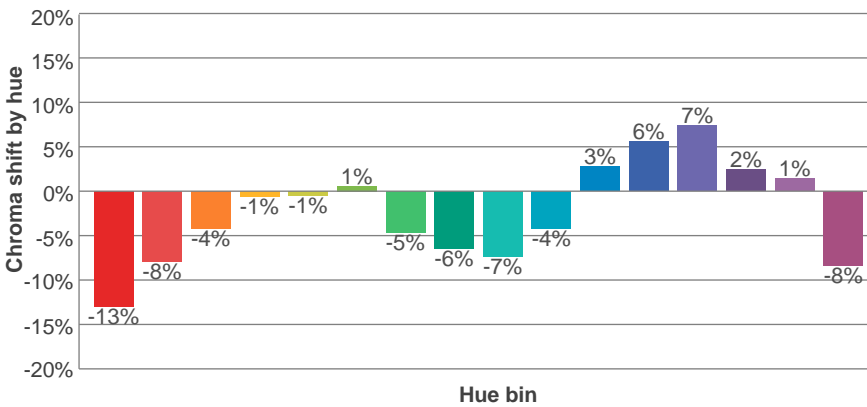
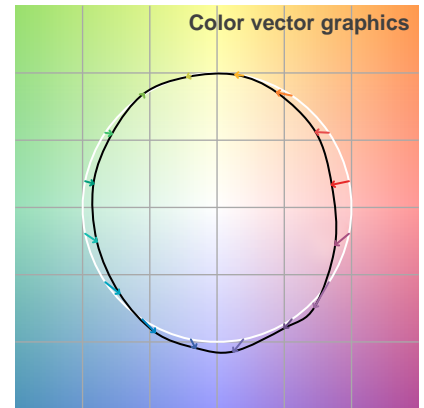
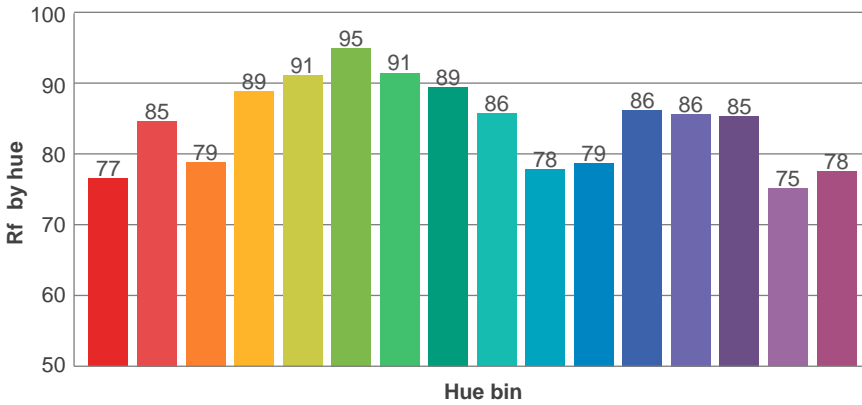
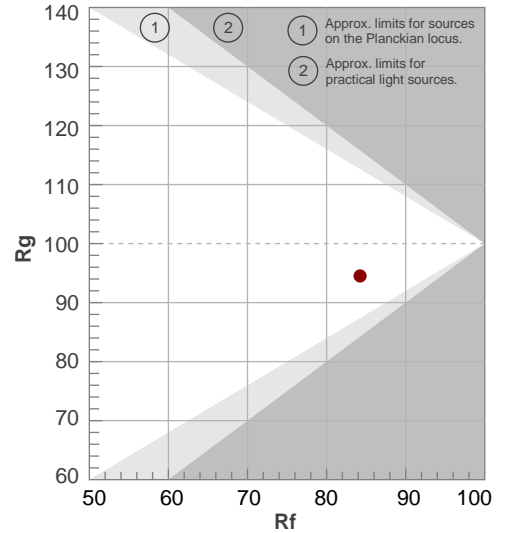

Beam details

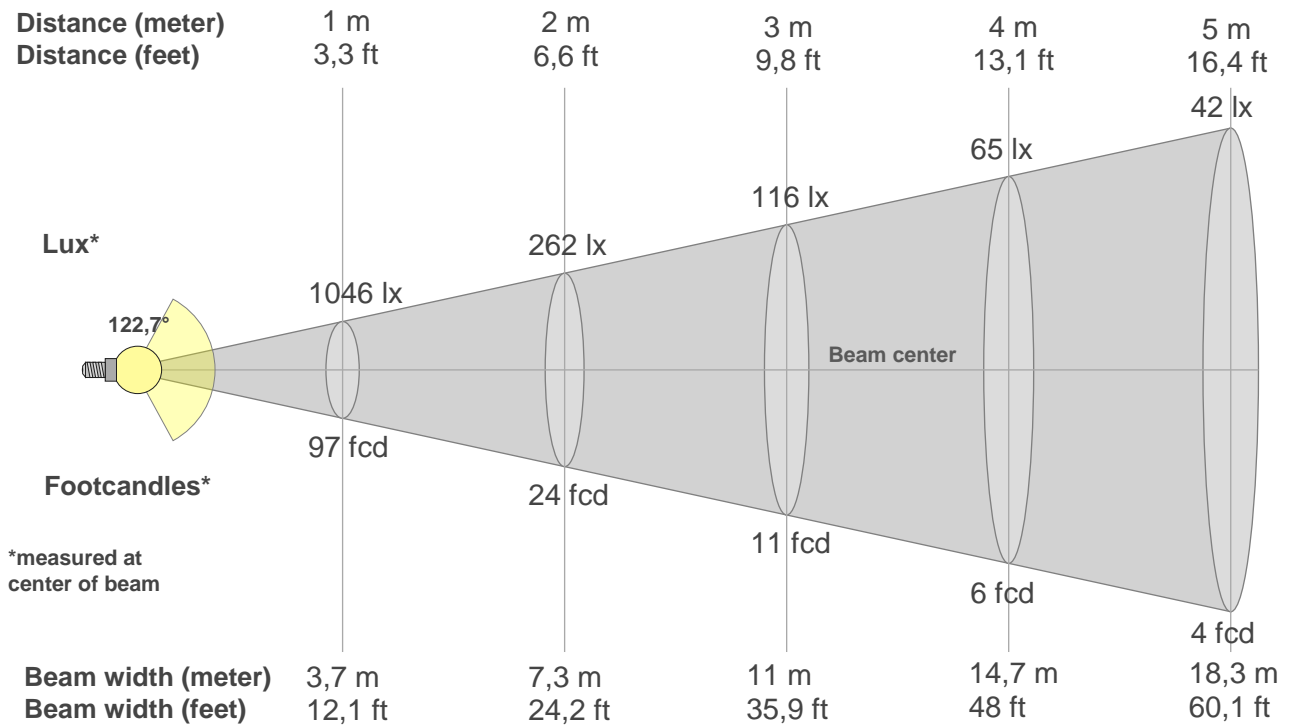

Beam intensities from 1-20m

{BEAM_INT_TABLE_START}

m	m	m	m	m	m	m	m	m	m	m	m	m	m	m	m	m	m	m	m	m
ft	ft	ft	ft	ft	ft	ft	ft	ft	ft	ft	ft	ft	ft	ft	ft	ft	ft	ft	ft	ft
lx	lx	lx	lx	lx	lx	lx	lx	lx	lx	lx	lx	lx	lx	lx	lx	lx	lx	lx	lx	lx
fcd	fcd	fcd	fcd	fcd	fcd	fcd	fcd	fcd	fcd	fcd	fcd	fcd	fcd	fcd	fcd	fcd	fcd	fcd	fcd	fcd

Intensities in 0° c-plane

0°	9°	18°	27°	36°	45°	54°	63°	72°	81°	90°	99°	108°	117°	126°	135°	144°	153°	162°	171°
1046	1044	1015	965	895	804	701	592	485	383	286	202	132	77	36	16	13	12	10	10
100%	100%	97%	92%	86%	77%	67%	57%	46%	37%	27%	19%	13%	7%	3%	2%	1%	1%	1%	1%

Intensities in 90° c-plane

0°	9°	18°	27°	36°	45°	54°	63°	72°	81°	90°	99°	108°	117°	126°	135°	144°	153°	162°	171°
1046	1021	972	893	790	667	530	383	234	101	27	14	11	9	8	8	9	10	10	10
100%	98%	93%	85%	76%	64%	51%	37%	22%	10%	3%	1%	1%	1%	1%	1%	1%	1%	1%	1%

Intensities in 180° c-plane

0°	9°	18°	27°	36°	45°	54°	63°	72°	81°	90°	99°	108°	117°	126°	135°	144°	153°	162°	171°
1046	1044	1015	965	895	804	701	592	485	383	286	202	132	77	36	16	13	12	10	10
100%	100%	97%	92%	86%	77%	67%	57%	46%	37%	27%	19%	13%	7%	3%	2%	1%	1%	1%	1%

Intensities in 270° c-plane

0°	9°	18°	27°	36°	45°	54°	63°	72°	81°	90°	99°	108°	117°	126°	135°	144°	153°	162°	171°
1046	1021	972	893	790	667	530	383	234	101	27	14	11	9	8	8	9	10	10	10
100%	98%	93%	85%	76%	64%	51%	37%	22%	10%	3%	1%	1%	1%	1%	1%	1%	1%	1%	1%

Beam angle 50%	Field angle 10%	Cutoff angle 2,5%	Intensity ratio in 120° cone	Intensity ratio in 90° cone
122,7°	197,9°	227,7°	64,0%	42,6%

UGR

Glare Evaluation According to UGR

p Ceiling	70	70	50	50	30	70	70	50	50	30	
p Walls	50	30	50	30	30	50	30	50	30	30	
p Floor	20	20	20	20	20	20	20	20	20	20	
Room size X Y	Viewing direction at right angles to lamp axis					Viewing direction parallel to lamp axis					
2H	2H	21,0	22,2	21,3	22,6	23,0	19,7	20,9	20,0	21,3	21,7
	3H	23,3	24,5	23,8	24,9	25,3	21,2	22,4	21,7	22,8	23,2
	4H	24,6	25,7	25,1	26,2	26,6	21,8	23,0	22,3	23,4	23,9
	6H	26,0	27,1	26,5	27,5	28,0	22,4	23,4	22,8	23,9	24,4
	8H	26,8	27,8	27,3	28,3	28,8	22,6	23,6	23,0	24,0	24,6
	12H	27,7	28,7	28,2	29,1	29,7	22,7	23,7	23,2	24,2	24,8
4H	2H	21,6	22,7	22,1	23,2	23,6	20,6	21,8	21,1	22,2	22,6
	3H	24,2	25,2	24,7	25,7	26,3	22,5	23,5	23,0	24,0	24,6
	4H	25,6	26,6	26,1	27,1	27,7	23,3	24,3	23,8	24,7	25,4
	6H	27,2	28,1	27,8	28,6	29,1	24,0	24,8	24,6	25,3	25,9
	8H	28,1	28,9	28,7	29,4	29,9	24,2	25,0	24,8	25,5	26,1
	12H	29,1	29,8	29,7	30,3	31,0	24,4	25,1	25,0	25,7	26,3
8H	4H	26,0	26,8	26,6	27,3	27,8	24,1	24,9	24,7	25,4	25,9
	6H	27,9	28,5	28,5	29,1	29,8	25,1	25,7	25,7	26,3	27,0
	8H	28,9	29,5	29,6	30,1	30,9	25,6	26,1	26,2	26,8	27,5
	12H	30,2	30,7	30,9	31,3	32,0	26,0	26,5	26,7	27,1	27,8
12H	4H	26,0	26,7	26,6	27,3	27,9	24,3	25,0	24,9	25,5	26,1
	6H	28,0	28,6	28,6	29,2	30,0	25,5	26,1	26,1	26,7	27,5
	8H	29,2	29,6	29,8	30,3	31,0	26,1	26,6	26,8	27,2	28,0
Variation of the observer position for the luminaire distance S											
S = 1.0H	0,1 / -0,1					0,1 / -0,1					
S = 1.5H	0,1 / -0,1					0,1 / -0,2					
S = 2.0H	0,2 / -0,2					0,2 / -0,4					
Standard table	n/a					n/a					
Correction summand	n/a					n/a					
Corrected glare indices referring to 3843 lm total luminous flux											

Light planning

Coefficients of Utilization

Ceiling reflectance	80				70				50			30			10			0			
Wall reflectance	70	50	30	10	70	50	30	10	50	30	10	50	30	10	50	30	10	0			
Floor reflectance	20	20	20	20	20	20	20	20	20	20	20	20	20	20	20	20	20	20	20	20	0
RCR	(RCR: Room Cavity Ratio)																				
	Room Values are expressed as percentage of Lumens delivered to the task surface																				
0	117	117	117	117	113	113	113	113	106	106	106	100	100	100	94	94	94	91			
1	104	99	94	89	101	96	91	87	90	86	82	84	81	78	79	77	75	72			
2	94	85	77	71	91	82	75	69	77	71	66	73	68	64	68	64	61	58			
3	85	74	65	58	82	72	63	57	67	60	55	63	58	53	60	55	51	48			
4	78	65	56	49	75	63	54	48	60	52	46	56	50	45	53	48	43	41			
5	71	58	48	41	69	56	47	41	53	45	40	50	44	38	47	42	37	35			
6	66	52	43	36	63	51	42	35	48	40	34	45	39	33	43	37	32	30			
7	61	47	38	32	59	46	37	31	43	36	30	41	35	30	39	33	29	27			
8	57	43	34	28	55	42	33	28	40	32	27	38	31	26	36	30	26	24			
9	53	39	31	25	51	38	30	25	36	29	24	35	28	24	33	27	23	21			
10	50	36	28	23	48	35	28	22	34	27	22	32	26	21	31	25	21	19			

LAMPS (number of lamps)

Luminaire budgetary diagram

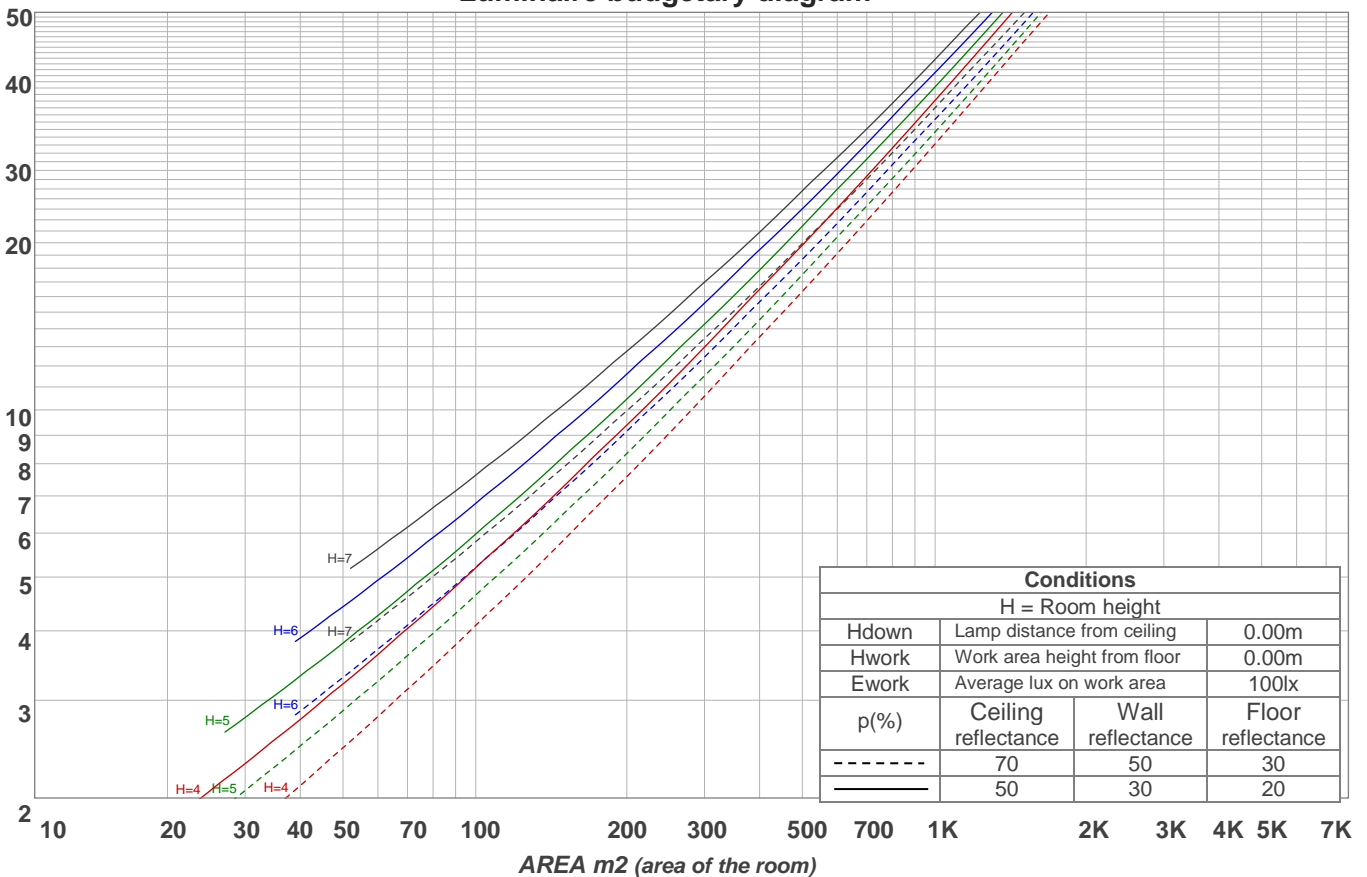

Zonal Lumen Summary

0°-10°	10°-20°	20°-30°	30°-40°	40°-50°	50°-60°	60°-70°	70°-80°	80°-90°
99,1 lm	285 lm	436 lm	534 lm	568 lm	540 lm	462 lm	353 lm	240 lm
90°-100°	100°-110°	110°-120°	120°-130°	130°-140°	140°-150°	150°-160°	160°-170°	170°-180°
152 lm	88,7 lm	43,3 lm	18,3 lm	9,60 lm	6,87 lm	4,80 lm	2,87 lm	0,971 lm

Stabilization

Warmup curve

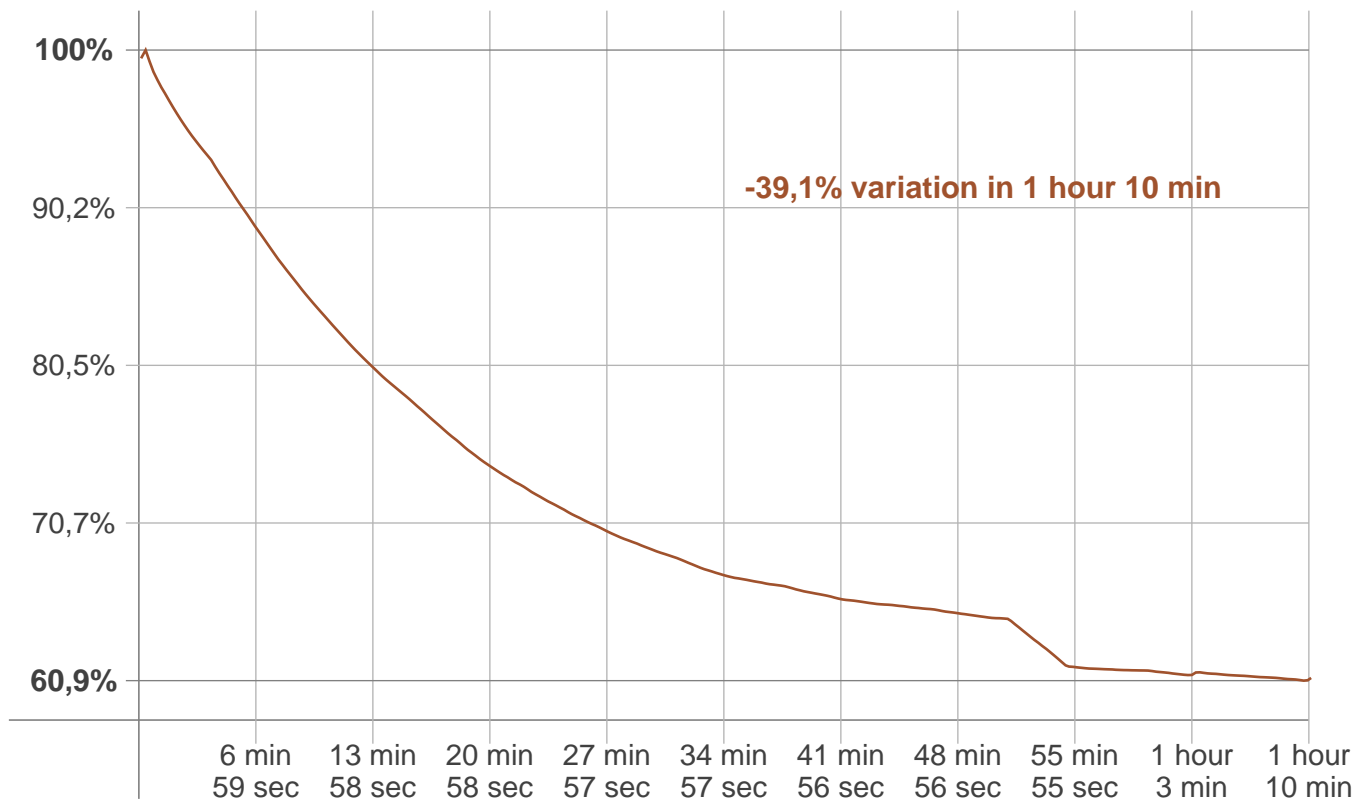

Warmup result

Warmup time:	1 hour 10 min
Warmup variation	-39,5%

Warmup conditions

Stable period:	15 min
Stable change max:	2,0%
Minimum time:	15 min

Color temperature change

CCT start	CCT change	CCT end
4798 K	+59 K	4857 K

Output change

Output start	Output change	Output end
4190 lm	-347 lm	3843 lm